

CLEAN
COOKING
ALLIANCE



LPG SAFETY, INNOVATION,
AND MARKET GROWTH





Photo by Gaelle Marcel on Unsplash

Cover photo: World LPG Association

ACKNOWLEDGEMENTS

The Clean Cooking Alliance (“Alliance”) works with a global network of partners to build an inclusive industry that makes clean cooking accessible to the three billion people who live each day without it. Established in 2010, the Alliance is driving consumer demand, mobilizing investment to build a pipeline of scalable businesses, and fostering an enabling environment that allows the sector to thrive. Clean cooking transforms lives by improving health, protecting the climate and environment, empowering women, and helping consumers save time and money.

ENEA Consulting (“ENEA”) is an independent strategy consultancy specialized in the energy transition and sustainability, with offices in Paris, Melbourne, and Hong Kong. ENEA Consulting works with a wide range of actors in the energy value chain, from global energy majors to major investors, from entrepreneurs to international institutions. In the energy access space, the firm has provided consultancy services to more than 60 companies, social enterprises, NGOs, and public institutions to help them increase access to energy in developing countries.

Menecon Consulting is an independent, UK-based energy-consulting firm offering independent and professional advice on public and private sector clients on all aspects of energy policy, strategy, and economics, including climate change, other environmental challenges, and access to modern energy services.

The Alliance, specifically its Private Sector and Investment team led by Peter George with Seema Patel, and its Strategy and Development team, led by Samiksha Nair with Sheridan Hyland, commissioned this report. The Alliance and ENEA would like to thank all the partners who contributed their content, time, resources, and expert insights.

The Alliance is grateful to Chevron Corporation, whose support made this report possible.

EXECUTIVE SUMMARY

Issues related to LPG safety, both real and perceived, inhibit the uptake of LPG by consumers, slowing potential market growth, and contributing to lack of confidence in return on investment for both investors and companies. Innovative technologies and other potential solutions are emerging that both purposefully and indirectly alleviate safety concerns.

When paired with robust policies and strong regulatory enforcement, complemented with consumer education and awareness raising, the effectiveness and market penetration of these technologies is amplified. In other words, prioritizing interventions to address safety issues can serve as an accelerant for investment and market growth.

Switching to LPG for household cooking could bring environmental, economic and health benefits to billions of people. Over a third of the global population continues to rely primarily on non-sustainable traditional biomass and other polluting fuels such as kerosene and coal for cooking, causing indoor air pollution that causes an estimated 3.8 million premature deaths each year. By contrast, LPG burns very cleanly and does not contribute to indoor air pollution. It is also convenient and efficient. Although LPG is derived from fossil fuels, switching from traditional fuels can reduce net carbon dioxide (CO₂) when biomass is not replaced once it has been harvested. However, reaping the benefits of LPG requires building profitable businesses that can scale and instill long-term confidence in both investors and consumers.

For all the benefits that LPG can bring, many households are reluctant to make the switch because of concerns about the safety of handling and using the fuel. Like all other forms of energy, LPG is potentially hazardous if mishandled or misused. Accidents associated with LPG can and do occur,

though several studies have demonstrated that LPG is safer in practice than most other cooking solutions, particularly kerosene. Aside from the human suffering and financial cost involved, LPG-related accidents undermine consumer confidence in the fuel. The dramatic nature of some LPG accidents has led to sensationalist reporting, which has stoked public fears about LPG.

Unsafe practices around LPG can impede investment flows, business growth, commercialization and market entry. For LPG businesses and large multinationals in particular, the risks and costs associated with LPG safety has reduced appetite for the sector, thereby reducing the uptake of LPG, particularly in sub-Saharan Africa. In order to build a dynamic and financially sustainable clean cooking industry, for both LPG and other clean cooking fuels, ensuring effective safety best practices is critical. New innovations that can make LPG more affordable while addressing safety concerns have the potential to spur private sector investment.

Addressing issues related to safety can be both an asset and liability to the growth of LPG as a widespread and viable clean cooking fuel. LPG businesses, concerned about safety, may choose not to invest in LPG given the cost of managing safety challenges and reputational risks. Strategies that prioritize safety considerations are complex. To be effective, safety standards and precautions must be adopted by actors throughout the value chain.

Specifically, there are safety considerations at each stage of the journey along which an LPG cylinder travels: from the cylinder factory, to the refilling plant, to the final household end user. Safety is also important in the supply of the fuel itself from the import terminal, refinery or gas-processing plant to the refilling plant. At each stage, there are safety risks—notably in refilling cylinders, transporting them to local distributors and then customers, and using them in the kitchen.

It is vital that all stakeholders involved in the distribution, regulation, and consumption of LPG have a clear view of the various safety challenges and potential mitigation measures to encourage increased fuel use and investment in supply networks.

- » A strong regulatory framework is crucial to ensuring public safety by imposing and enforcing strict rules on the handling of LPG along the cylinder supply chain. In particular, policies and regulations that impose the branded cylinder recirculation model,¹ whereby distributors and marketers are responsible for cylinder safety—including inspection, maintenance, and replacement—throughout their lifetimes, are vital to providing incentives for re-fillers to inspect and repair cylinders properly.
- » Awareness raising and education can bring down accident rates substantially and eradicate misunderstandings and misconceptions about safety.
- » Together, these approaches can reassure consumers that cooking with LPG is safe and give private sector investors—from local distributors to large energy majors—confidence that the LPG market will be healthy enough to generate adequate returns on investment.

Developing these frameworks and improving enforcement can often be a long and complicated process, requiring buy-in from stakeholders along the LPG value chain, as well as effective and rigorous enforcement of established regulations. The effectiveness of these regulations becomes particularly challenging once illegal practices become pervasive, as is the case in certain key markets including, but not limited to Kenya, South Africa, and India.

Technical innovations to overcome safety issues can be an effective complementary approach to regulation and education and training by enhancing safety along the LPG value chain and addressing barriers to market penetration, expansion, and commercialization. Several innovative technologies and business models are already emerging which hold the promise of reducing operating costs and increasing the attractiveness for investors, in addition to enhancing safety along the various stages of the LPG cylinder and fuel supply chain. In most cases, these solutions are being pursued by private sector companies, in some cases with the explicit support of government authorities. Based on an in-depth industry survey, eight categories of innovations have been identified and differentiated into two groups, each with different time-to-market horizons: low tech solutions that can be implemented at relatively low cost, and more complex and “game-changing” technologies that hold promise in the longer term.

Low-tech solutions

Four lower-tech solutions represent opportunities for more immediate results to increase safety and promote the uptake of LPG, at a relatively affordable cost for companies and consumers:

- » **Home delivery** of cylinders, which, in addition to offering convenience to the customer, permits

¹In the branded cylinder recirculation model (BCRM), government-licensed LPG marketers invest in and own the cylinders. They are responsible for cylinder safety—including inspection, maintenance, and replacement—and refilling throughout its lifetime. In the customer-controlled cylinder model (CCCM), end users own the cylinders and bring them to filling stations to be refilled as needed. With CCCM, cylinders in circulation tend to become unsafe due to a lack of incentives for the re-filler to inspect and repair the cylinders, as well as a lack of clear rules and incentives for customers to have cylinders properly inspected and repaired.

professional delivery personnel to correctly install LPG cylinders, teach customers how to cook safely with LPG, and reassure them about safety. Home delivery is increasingly commonplace in developing countries, already reaching 55% of Kenyan LPG customers, and 95% of those in Brazil.

- » **Cylinder tracking**, such as through QR codes and radio-frequency identification (RFID), which improves the traceability of cylinders along their lifecycle and enhances safety during the transport and refilling of cylinders, while improving operational management for companies. These codes are becoming mandatory in many countries.
- » **Innovative digital media**, such as social networks and content sharing platforms, which allows businesses and authorities to transmit safety and other marketing messages to customers via the Internet and mobile phones, even in remote areas, to educate them and raise their awareness about LPG safety.
- » **Advanced cooking equipment**, such as advanced hoses and improved valves, which can significantly reduce the incidence of gas leakages and accident rates in homes, often at very low cost. These technologies are becoming commonplace in larger emerging markets such as India but are not yet widely used lower-income countries.

- » **Home delivery** increases consumer satisfaction and customer loyalty, as well as safety.
- » **Cylinder tracking** improves supply-chain management and reduces operational costs, as well as ensures supply chain safety.
- » **Digital media** not only can be used to transmit safety messages, but also cooking tips, special promotions, and other methods to increase customer loyalty.
- » **Advanced cooking equipment** can not only give customers more reassurance on safety, but also create an additional revenue stream for distributors.

- » **Investors** should study businesses that are developing technologies in these areas. Increased investment is needed to support their uptake across the developing world, particularly in lower-income countries. In addition, these technologies all have the chance to be deployed at scale to the hundreds of millions of households already using LPG, representing a unique investment opportunity.
- » **Governments and development partners** should support innovation in these areas through project funding and strategic partnerships. In the case of digital awareness campaigns, public funding can be used. Development partner finance can also be used to fund pilots of these technologies in existing distributors, to encourage them to improve safety practices, and ensure increased customer engagement.
- » **Regulators** should consider promoting these solutions by introducing and enforcing at least basic standards, such as making cylinder tracking and certain hose and valve technologies mandatory.

With respect to these lower-tech solutions, the following actions are recommended:

- » **LPG distributors** should explore opportunities to roll out these low-cost technologies and business practices. Most of these technologies have “dual-wins” for distributors.

Advanced technologies

Four emerging, innovative technology-enabled solutions also have the potential in the longer term to make a significant contribution to increasing safety, as well as offering other benefits to distributors and/or consumers:

- » **Composite cylinders**, which are lighter, explosion-proof, corrosion-free, provide higher mechanical resistance, and are sometimes translucent (making the gas level visible), can enhance safety, as well as make cooking with LPG more convenient and easier for households. They are increasingly being adopted in some advanced economies and are starting to be rolled out in key emerging markets. They undoubtedly represent the future of LPG cylinders, but their relatively high cost is likely to be a barrier to their adoption in lower-income developing countries in the near term.
- » **Smart metering systems / pay-as-you-cook business models**, which use smart valves that allow end customers to keep track of their exact gas consumption and pay with mobile money for small volumes of LPG according to their needs (hence the “pay-as-you-cook” expression). In addition to improving affordability by reducing the upfront cost of LPG, these systems also increase safety by allowing firms to better track cylinder location and customer usage, as well as integrating home delivery. The business model is being tested, costs are coming down, and regulations and standards are being defined.
- » **Smart gas sensors**, which permit monitoring of the volume of gas in the cylinder, automatically triggering doorstep deliveries and alerting the user and distributor in the event of a gas leak.
- » **Advanced leak detection systems** installed at distribution facilities and in homes, which are stand-alone devices that detect leaks and



LPG stove installed in a school in Haiti (Rachel Mahmud/World Central Kitchen)

through “IoT”² platforms and potentially trigger emergency procedures.

More R&D and scaling up of these advanced innovations will be needed to make them more affordable on a larger scale. Pilot projects will be an important element in the process of bringing some of these technological solutions to market. Partnerships between local players and industry majors can also accelerate their roll-out, as well as identify sustainable business plans. These solutions are most likely to thrive in urban and peri-urban areas first before becoming more affordable and better adapted to rural areas at a later stage.

More detail on each of the eight proposed solutions and where in the LPG supply chain their implementation could be most beneficial is provided in later chapters of this report. The remainder of this report is structured to first provide a brief context of the role of LPG and outstanding barriers to its market penetration. It then broadly introduces the topic of LPG safety in the cooking fuel sector. This leads into a detailed discussion in the following section regarding the safety considerations at each step of an LPG cylinder’s lifecycle, setting the stage for identifying existing and emerging technological innovations that could be utilized as market levers by the private sector, policy-makers through regulatory interventions, and in partnership with consumers through education and training. The subsequent chapters present the findings of in-depth surveys of the advantages and disadvantages of each of the eight solutions described above, together with an assessment of their potential to enhance safety and for market roll-out. The report concludes with actionable recommendations for the different stakeholders in the LPG sector.

The Clean Cooking Alliance launched the inception of this report in the context of its Clean Cooking Forum 2019, held in Nairobi on November 5-7, 2019.

Among the various sessions that took place, “Safety First: Best Practices in LPG” gathered interested industry specialists and other professionals. The overview and key takeaways of the discussion are available in the Appendix 1 of this report. In the months that followed, the Alliance, assisted by ENEA and Menecon, engaged with numerous and diverse stakeholders to capture their insights on challenges and opportunities accompanying the emergence of technological solutions tackling LPG affordability, accessibility and safety. This report is the result of that extensive research.



TABLE OF CONTENTS

Acknowledgement.....	2
Executive Summary.....	3
1. Context.....	9
2. Safety issues along the journey of an LPG cylinder.....	13
3. Improving LPG safety.....	21
4. Assessment of technology solutions....	27
5. Conclusions and recommendations.....	55
Appendix 1 – Safety First.....	59
References.....	61

²Internet of Things - A network of Internet-connected objects able to collect and exchange data.

1. CONTEXT

Liquefied petroleum gas (LPG) as a cooking solution is relatively mature compared to other options in terms of market maturity, yet a few critical hurdles remain that hinder market growth in many countries.

Clean cooking challenges and the role of LPG

LPG is particularly well suited to domestic cooking and heating because of its clean-burning attributes and practical advantages over both solid fuels and kerosene. LPG burns very cleanly, thereby not causing indoor air pollution experienced by the 40% of the population (about three billion people) who rely on open fires or inefficient stoves to cook their food [1]. Burning unsustainable biomass also contributes to global warming by releasing large amounts of carbon dioxide (CO₂) and black carbon into the atmosphere [2]. Although LPG is derived from fossil fuels, switching from traditional fuels to LPG can reduce net CO₂ when considering biomass that has not been sustainably harvested. As an example, Kenya loses 10.3 million m³ of wood from its forests every year from firewood and charcoal consumption, a major contributor to the country's 0.3% annual deforestation rate. Wood and charcoal fuel use, including black carbon emissions, contribute 25 million tons of CO₂ eq. each year, approximately 40% of Kenya's total GHG emissions [3]. It is estimated that LPG stoves emit 50% less carbon dioxide equivalent than conventional biomass stoves [4] [5].

Table 1 - Percentage of population relying on LPG cooking [11]

	Nigeria	Kenya	Ghana	Senegal	Ethiopia
Urban	16%	24%	36%	55%	2%
Rural	0%	8%	9%	5%	0%

A high rate of switching to LPG has already occurred in several countries, resulting in major environmental and health improvements. A government-led program to push households to adopt LPG in Indonesia drove down fuelwood consumption for cooking from 50% to 24% and kerosene from 37% to 4% between 2007 and 2015 [1]. The net social benefits from avoided carbon emissions and reduced forest loss that resulted from this program are estimated at US\$4.9 per household-month, compared with US\$1.6 for improved charcoal stoves [6]. The economic benefits could be seven times the cost of implementing the program [7].

Over 2.5 billion people in resource-poor settings worldwide use LPG for some cooking tasks, including millions more in developed countries [8]. Rates are generally highest in developing Asia and lowest in sub-Saharan Africa [9]. In India, around 75% of the population are now using LPG [10] and per capita consumption has risen to around 16 kg per person per year, thanks in part to recent large subsidized programs. In some developing countries with higher average household incomes, such as Brazil and Morocco, LPG penetration is close to 100%.

Per capita consumption of LPG for cooking is extremely low in most sub-Saharan African countries, averaging less than 5 kg in most countries, compared with a world average of 17 kg and over 65 kg in Morocco. LPG is used by just 17% of households in urban areas of Tanzania and 26% in Ghana (Table 1), with the penetration in rural areas remaining even lower.

In countries where residential use of LPG remains limited and LPG business growth slowed, the cause stems from issues broadly related to supply, demand, and the policy and regulatory environment.

A recent report by the Clean Cooking Alliance outlined the main barriers to the development of LPG markets in developing countries [13], chief among which are:

1. **Regulation and market structure:** Clear regulations and enforcement on the handling, distribution, and dissemination of LPG are needed

to ensure public safety and private sector confidence to invest.

2. **Finance along the value chain:** Lack of access to financing and concessional funding for LPG businesses can inhibit market expansion.

3. **Affordability:** The upfront cost of purchasing an LPG "starter pack," including the burner, cylinder, and first refill of gas, as well as the recurring costs of cylinder refills, continues to be a barrier to consumer adoption.

4. **Safety:** Perception of safety risks and poor safety practices in the value chain can discourage consumer willingness to switch to LPG and hinder market growth. This topic in particular has implications for the previous three barriers and is discussed in more detail in the rest of the report.

Figure 1 - Per capita consumption of LPG in the household sector in selected developing countries in Asia and Africa, 2017 [12]

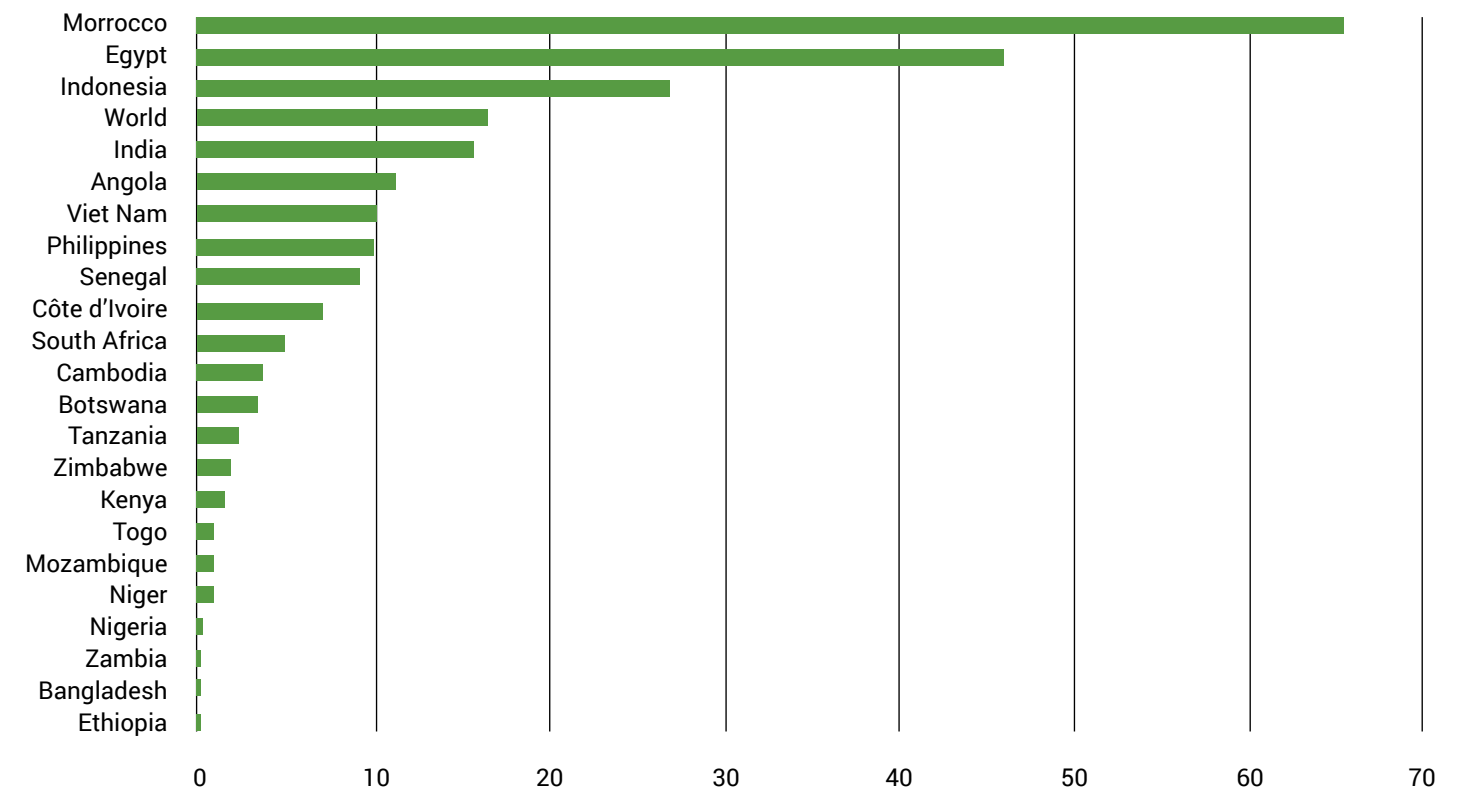

LPG safety – The role of perception and reality

When discussing LPG safety, the topic should be viewed from multiple angles, starting from the sourcing of the LPG all the way to the usage of the cylinder in the household.

Although LPG is a relatively safe cooking fuel, perceptions that it is more dangerous than other cooking solutions have proven to be a barrier to switching and hence, market development. The dramatic and devastating nature of some LPG accidents has led to sensationalist reporting and public fears about LPG. A few examples of LPG safety perception surveys in emerging markets are compiled in Box 1 to the right.

Serious accidents involving LPG are relatively infrequent in most countries. The most common types of accidents involve non-fatal burns caused directly by the flame from the burner or fire caused by the flame setting light to objects in proximity, comparable to other cookstoves. More serious accidents can occur as a result of a leakage of gas from the pipe or burner and the subsequent ignition of the released gas. The most serious, yet extremely rare, type of accident, involves the gas inside the cylinder or storage tank exploding—an incident known as Boiling Liquid Expanding Vapor Explosions (BLEVE). This type of accident can only occur if the safety valve on the cylinder fails to release the gas inside in the event of the cylinder heating up (for example, if a fire breaks out in the building where the cylinder is stored), increasing the pressure.

In general, LPG-related accidents occur more frequently in the least developed countries, where safety standards are less respected and ill-enforced. In Indonesia, where a strong regulatory environment was adopted to frame the Zero-Kero program aiming at boosting LPG adoption, 582 LPG-related accidents were reported over the period 2007 to 2012, resulting in 16 deaths—just three per year out of the 220 million

Box 1 - Examples of surveys on LPG safety perception in emerging markets

In Indonesia, safety has been identified as the most important reason for people not adopting LPG [14].

A survey conducted in Lagos, Nigeria with a sample size of 519 households has indicated that 90% of non-LPG users were willing to switch to LPG but cited safety issues and high cost as potential barriers to switching [15].

In Peru, 87% of the participants of a survey reported their general perception that it is dangerous to cook with LPG due to the risk of risks of fires and explosion [16]. In another survey conducted in Puno, Peru, many participants perceived LPG stoves as dangerous and risky, and there were fears about the “possibility” of an explosion, even though none of them had ever experienced any LPG incident [17].

In a market survey of 400 households in Pemba, Mozambique, 79% believed LPG to be toxic, explosive or dangerous [18].

people that live in households and use LPG for cooking [1]. By contrast, in Cameroon, 20,955 households experienced LPG-related accidents accounting for 279 deaths and 4,270 injuries in 2004 alone [19].

Safety concerns also can discourage investment in the sector, particularly by large multinationals.

Ensuring zero accidents is a priority for multinationals, and LPG has risks which are described in detail below. A lack of investment in safety measures around LPG, particularly in a context of weak regulation and poor enforcement therefore poses both a reputational risk to businesses, as well as increasing operational costs. As one actor working for a major LPG player stated in an interview for this study: “LPG safety is the key issue for us in Africa and stops us investing in the sector at scale. We have even stepped back from certain countries due to safety concerns.”

In Nigeria, public authorities are calling upon the establishment of public-private partnerships (such as the upcoming one between the Ministry of Energy and Mineral Resources and Ibile Oil and Gas Corporation) to deepen LPG adoption by making sure that the product is available at an affordable rate. Lagos State’s Head of Service recently cited the fire incidents in the region as one of the reasons for increasing awareness on the proper use of the commodity as well as the need to raise standards of LPG activities in the State. The Ministry of Energy and Mineral Resources is trying to change the narrative about LPG use in order to increase penetration from the present 15% to 80% in the next five years. **It is estimated that at least \$2 billion worth of investment is still needed in the sector in Nigeria to reach this target [20].**

Ensuring that LPG is handled safely along the supply chain, from importer to the final consumer, is of paramount importance to both customer acceptability and investment appetite.

Figure 2 - Main reasons for not using LPG by households in Indonesia [14]

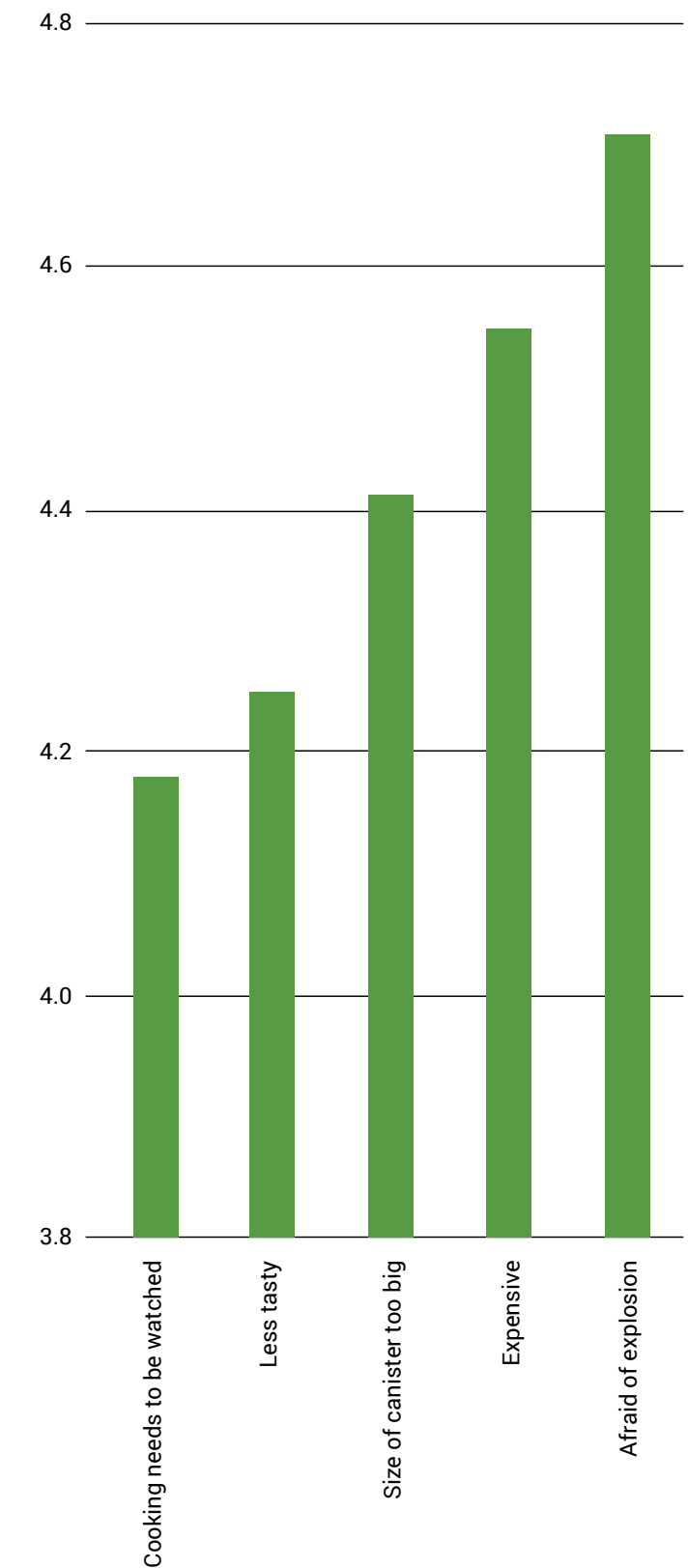

2. SAFETY ISSUES ALONG THE JOURNEY OF AN LPG CYLINDER

There are a set of safety considerations at each stage of the journey along which an LPG cylinder travels, from the refilling plant to the final household end user. Safety is also important in the supply of the fuel itself from the import terminal, refinery or gas-processing plant to the refilling plant. A typical cylinder

will go through many customers' hands, travel via various modes of transportation, and undergo filling and requalification (repair) at different facilities. This section examines, in detail, the different safety risks at each stage.

Figure 3 - Break down of the LPG cylinder lifecycle

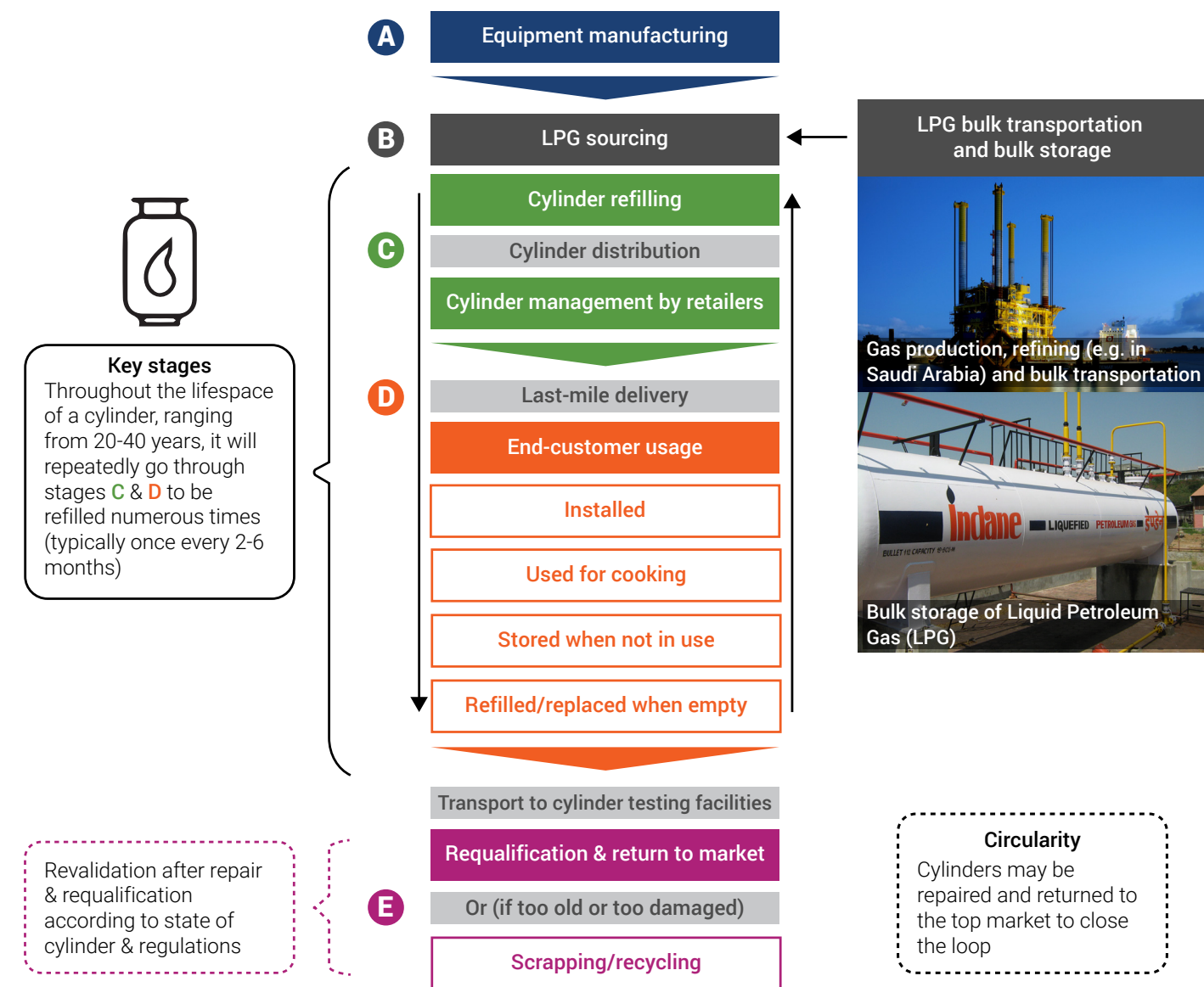

Example of LPG two-burner modern equipment

Equipment manufacturing

Ensuring the quality of the equipment used for cooking with LPG at the manufacturing stage is the first step towards the safe use of LPG. The most common manufacturing defects include poor cylinder welding (noted in interviews as the key stage where manufacturing faults can happen), faulty valve outlets and pressure gauges, and defective cookstoves (the figure below depicts the configuration of an LPG cylinder and associated fittings). If manufacturing defaults go unnoticed, leaks can occur leading to the accumulation of gas in enclosed area and the risk of fire.

Studies of LPG-related incidents demonstrate that poor manufacturing can be a leading cause of

accidents. A study analyzing burn admissions at a clinic in India has shown that most of those involving LPG cylinders were caused by leaks from the hardware, usually either due to cracks on the connecting hoses or defect valves and regulators [24].

Leakages of gas can also occur with the cooking equipment. In addition to the LPG cylinder, cooking with LPG also requires a cookstove or a "burner". LPG can also be used in ovens. In both cases, faulty knobs on the burner or oven can lead to gas escaping even when turned off, leading to a risk of fire.

New innovative cookstove equipment is emerging which deals with several of these risks and is discussed in more detail in the technology section.

Figure 4 - LPG cylinder and associated fittings [21] [22] [23]

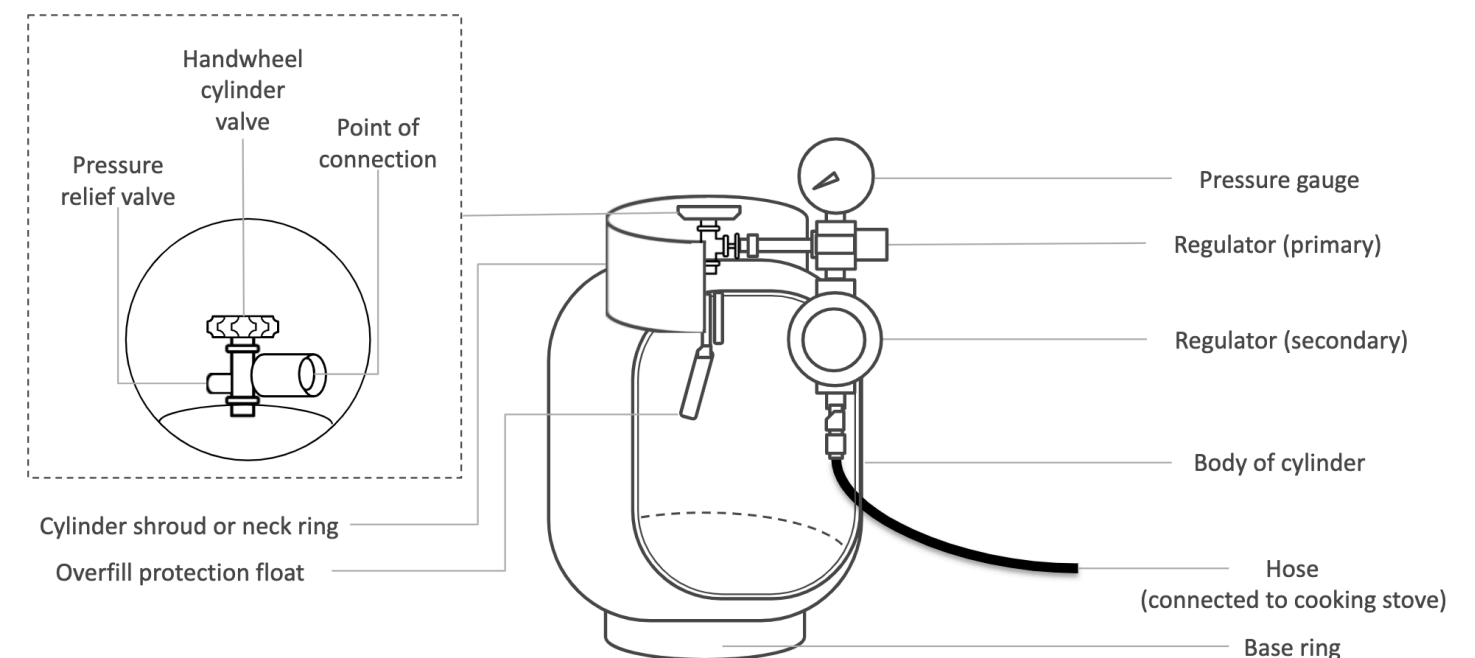



Men cooking with rudimentary LPG stoves in Jaipur, India.

LPG sourcing

At the first stage of the distribution chain, LPG is transported in bulk into the country, typically by ship, rail, or road. It is then transported to major storage facilities within the importing country. LPG is stored in bulk at the port terminal, refinery, or gas-processing plant before being transferred to regional hubs and facilities, ready for filling activities or industrial use. The largest spherical storage tanks each hold up to 100,000 tons while mid-scale storage sites usually store between 50 and 1,000 tons. Improper management of storage facilities can result in spillages.

Leakages of LPG from bulk storage or transportation facilities, when in contact with an ignition source,

can lead to fires and, in exceptional circumstances, explosions. **Accidents at this stage of the LPG supply chain can prove to be very harmful for the operators, the economic viability of the investments, and the reputation of the sector, undermining confidence in future investment.** Anecdotal evidence suggests that they can also undermine confidence in the safety of using the fuel at the household level, even though the consequences of household accidents are generally much less severe (cf. introductory chapter). This is what was observed in Accra, the capital city of Ghana, in the wake of an explosion at a gas station [28]. Coverage of such accidents by mainstream media can further exacerbate these fears and concerns, discouraging switching to LPG cooking.

LPG cylinder filling

The filling stage is a crucial step in the life of an LPG cylinder. Any error in the way the cylinder is filled can result in a serious accident further down the supply chain.

Cylinder filling plants vary in scale and sophistication, but all need to follow safety standards to ensure safety [29]. LPG filling facilities include simple single-station operations filling small numbers of cylinders, to high-technology plants serving hundreds of thousands of consumers. Cylinder filling operations should be carried out in accordance with a reputable technical standard or code such as ISO 10691 [30]. An important element of the refilling process is the testing and validation of the integrity of each cylinder as fit for service at every refill - before, during, and after the filling process. Re-fillers must avoid over-filling cylinders, as this can lead to excessive pressure and the risk of a gas leakage or explosion. To avoid such a risk, a cylinder must never be filled beyond 85% of its liquid capacity [31].

Illegal, unlicensed refilling operations that do not respect safety standards, sometimes involving adulterated gas, is a serious problem in some emerging LPG markets. These operations put the lives of those working in the plant and further down the supply chain at risk (see “Cylinder requalification and cylinder scrapping” paragraph below for a discussion of counterfeit equipment and the grey market).

Consistent training and regular checking and maintenance of the filling equipment according to strict procedures is vital to ensure its functionality in the long-term. For instance, at the post-filling stage, a fixed seal (shroud or dust cap), usually made of plastic, is normally fitted to the valve to protect it. Increasingly, LPG marketers are fixing a tamper-proof seal to the cylinder valve after refilling to reassure future customers of the integrity of the cylinder [29].

LPG cylinder distribution to retailers

Distribution of cylinders from refilling stations to dealers and retailers is usually carried out by road transport, which results in a risk of traffic accidents. In addition, cylinders may be damaged during transport, on-loading, or off-loading. Transportation can be the responsibility of the marketer itself or contracted out to logistics companies. The three main safety concerns with respect to the distribution of cylinders are as follows:

- » **The state of the vehicle used for transportation.** Resorting to second-hand trucks to transport goods is a common practice in developing countries. However, these carriers are often antiquated and in a poor state of repair, increasing the risk of the cylinders being damaged. Trucks regularly employed for transporting cylinders should be designed or adapted to minimize the risks of the cylinders being damaged. They should be inspected before they enter service and be properly maintained [29].
- » **The conditions under which the cylinders are transported in the vehicle.** Cylinders must always be transported in a vertical position to prevent damage and over-pressurization in the event of a shock. Whenever possible, full and empty cylinders should be segregated on the truck. Cylinders should be loaded onto the truck in crates with anchorage holes, straps, or ropes (natural hemp not nylon) to restrain the carried cylinders and prevent them from being damaged. Valve caps are particularly important at this stage in helping prevent moisture and dirt from entering the valve of the cylinder, in addition to providing protection from any potential impact [33].
- » **A lack of training and absence of emergency action plans.** Drivers and operators share the responsibility of ensuring safety and minimizing the likelihood of accidents on the road. Drivers should receive proper instruction and training from their employer or vehicle operator [34].



A gas filling station in El Fasher, Sudan [32]. Every morning, dozens of shop keepers come to the station to collect LPG cylinders for distribution to the city.

LPG cylinder management by retailers

Safety is also a concern at the point of delivery of cylinders to retail premises and their storage on site.

When taking deliveries, retailers may not check for irregular markings and logos on the cylinders. Labelling of cylinders by marketers ensures compliance with national regulatory frameworks or industrial best practices. This includes information such as the exact content of the cylinder (propane or butane), the name of the supplier, the volume or weight of the gas in the cylinder, and a warning of the flammable nature of the contents using symbols or text in the local language. The retailer should check this information, as well as checking for defects when they receive the cylinder. Doing so reduces the risk of accidents and the penetration of illegally filled cylinders on the market. Cylinder tracking, as described below in the innovation section, is a step towards this.

Safety concerns often arise from temperature, pressure, and humidity conditions in the store and from the way cylinders are stored.

Problems can occur when cylinders are not stored away from direct sunlight and sources of ignition or other flammable materials. It is also important that they are stored vertically (to prevent damage to the valve), in a dry, clean, ventilated space on a flat surface and not left standing in water or in the rain. Humidity can cause corrosion, which in turn can lead to leaks, while dust or dirt can obstruct the valves and regulators. High temperatures can result in excessive pressure inside the gas cylinder, increasing the risk of leakage.

The way in which cylinders are handled on retail premises can be a source of risk. Dropping, rolling, or dragging cylinders can result in damage to their integrity, increasing the potential for leaks. LPG leaks can cause cold burns if the gas touches the skin. Propane, with its low boiling point, is more hazardous in this respect than butane which, in cold conditions, is slower to vaporize and disperse. The eyes and body, when not protected, are particularly exposed when handling LPG [29].



Common last-mile LPG cylinder delivery practices in India [41], China [92] and Jordan [94].

Injuries can also occur in lifting cylinders, especially if they are heavier than the weight marked on the outside. A full steel cylinder weighs about twice that of an empty one, i.e. a full 6 kg cylinder weighs up to 12 kg [35]. The handling of cylinders should be done with mechanical lifting devices and trolleys wherever possible to avoid injuries to employees. Manual handling of cylinders can also lead to accidents caused by falling of cylinders if employees do not wear protective equipment such as suitable safety shoes. Chronic harm due to repetitive manual lifting is also common with wrong posture causing work-related musculoskeletal disorders (MSDs), such as pain and injuries to limbs and joints [36].

It is essential that retailers provide staff with adequate training and supervision. Training is the first step towards reducing employees' risk of injury and ensuring that the integrity of the cylinders is preserved. For instance, valves should only be removed by trained personnel using procedures which ensure that the cylinder is no longer pressurized [33].

Last-mile delivery

The delivery of cylinders to households either by the retailer or the customer themselves if they collect the cylinder from the retail premises is particularly prone to safety risks. In several countries, delivery to the home by retailers or sub-contracted professional delivery companies is common. In Brazil, example, 95% of the cylinders used by the country's 42 million households that rely on the fuel were delivered

and installed by distributors in 2014 [37]. In other countries, like India, self-installation is common: in the state of Uttar Pradesh, only 29% of households obtain their cylinders through home delivery [38]. Where self-delivery is common, additional efforts are required to educate consumers on the best way to carry the cylinders home without damaging them and how to install them safely. Home delivery is discussed in more detail later in this report.

The risk of LPG being delivered to final customers in an unsafe manner is particularly acute in rural areas, away from modern transport infrastructure.

Most poor rural households do not own cars, so they must rely on other forms of transport such as bus, taxi, motorcycles, animals, or boats to carry the cylinder. The risk of damage to the cylinder through mishandling is inevitably that much greater in those cases [39]. Many also travel long distances on foot while carrying heavy cylinders, which poses a risk of injury as well as damage to the cylinder by being dropped. For instance, many rural LPG customers in India must travel several kilometers to the nearest LPG retail outlet [38]. The long distances to LPG retailers was one of the main reasons cited for the low rate of LPG adoption in a recent case study of Ghana's rural LPG scale-up program [40].

End customer usage

There are several safety risks involved in using LPG in the home or business, associated with the poor installation of the equipment, ill-adapted cooking

methods, unsafe storage of the cylinder, and poor maintenance of the equipment.

» **Incorrectly performed installation:** As for delivery to the home, a newly purchased or exchanged cylinder may be installed by the customer himself or by the LPG marketer or retailer. The operation is repeated every time the cylinder needs to be refilled, i.e. everyone to six months depending on consumption. When the company is responsible for installation, trained professionals can ensure that all the conditions for safe use of the cooking system are met. Furthermore, this interaction represents an opportunity for the professional to inform and educate the customers on the correct use and placement of the cylinders and answer to any questions about how to cook safely with the fuel. This greatly reduces the risk of any mishap. When customers take care of the installation themselves, there is a greater risk of inappropriate practices, such as horizontal positioning of the cylinder, proximity to ignition sources, hoses left at the mercy of rodents, and soiling of valves and regulators. It is of critical importance that customers are made aware of these risks and how to handle disconnecting and installing the cylinders to their cooking system safely.

» **Ill-adapted cooking methods:** Another source of safety hazard resides in cooking practices. The most common examples of imprudence and negligence include cooking at floor level without an elevated slab for the cooktop, leaving the cylinder valve open, or letting children play in proximity to the equipment. In addition, some end users continue to use traditional fuels intermittently in a stove placed next to the gas cylinder, increasing the risk of an accident. In some cases, kerosene is stored alongside the LPG cylinder. Other potential causes of accidents include forgetting about a saucepan placed on the stove, which can lead to liquids overflowing, extinguishing the flame and causing a gas leak [42].

» **Improper storage at the end customer's home:** When not in use, the best practices for storage of the cylinder applicable to professional retailers are also valid for households, especially in rural areas where houses' vulnerability to extreme weather conditions and parasites is higher. It is also important to note that in developing countries, many poor families live in one-room houses and don't have the luxury of a separate kitchen [43]. This means there may be multiple cooking sources located close to one another, increasing the risk of fire.

» **Lack of care and irregular maintenance of equipment:** Whether the cooking equipment is their property or that of the marketer, end customers are still responsible for keeping appliances in good condition. Failure to regularly inspect the cylinder, valves, or hoses to identify potential leaks can lead to fatal accidents. It seems obvious that leaks should never be detected using a candle or cigarette lighter, yet accidents caused by such practices still occur. Equipment must be serviced regularly by qualified professionals [42]. A lack of information about how to respond to a gas leak or, worse, fire can worsen the danger.

Overall, poor safety practices at home due to a lack of awareness and education create a misperception on the part of end users that LPG is dangerous and discourage others from switching to the fuel. In a study conducted in Guatemala in 2015, participants reported feeling unsafe using the LPG cylinder and stove. They had received no information or instructions on safe installation or use [44].

Cylinder end-life

LPG cylinders typically require regular maintenance to ensure they are still functioning properly. In addition, at periodic intervals, cylinders need to be removed from the filling line and given a much more rigorous check—a procedure known as “requalification.” This usually involves the removal—



Mobile money being used to purchase specific quantity of LPG

and sometimes replacement—of the valve, a thorough internal and external visual inspection of the cylinder, a hydraulic test (for leakage), and other tests such as an acoustic check. After the cylinder has passed the test, a new inspection date is stamped onto the neck ring. Cylinders requiring urgent maintenance or repair should be dealt with immediately by trained and properly supervised employees as they are potentially hazardous, and a backlog should never be allowed to accumulate within the cylinder testing area [29]. The requalification of LPG cylinders is a government requirement in most countries, with the frequency typically ranging from 1-15 years.

In a similar fashion to what can happen at the refilling station, a lack of control of the requalification process can allow illicit practices to proliferate, and LPG cylinders showing no markings or with wrong or misleading information may be wrongly put back into circulation. **A major problem hampering safety of requalification practices is the existence of parallel grey markets, adding counterfeit or unsuited products in the market.** That is why new regulations were approved in Kenya in 2019 after it was discovered that the interchange of LPG cylinders, which had been permitted under previous regulations, had seen brands lose track of 90% of their cylinders, discouraging investment in further cylinders and requalifica-

tion of existing ones, as nameless re-fillers who could not be made accountable for safety breaches resold cylinders [45].

When a cylinder has reached the end of its life it must be destroyed in a safe manner. Even an empty LPG cylinder will contain small amounts of hazardous vapor and therefore must be handled safely. Empty cylinders should always be treated as if they contained liquid, especially if they are to be disposed of [46]. Disposal techniques include punching large holes into both halves of the pressure vessel. Punching a hole in only one half leaves the possibility of the other half being recovered and reused. Domestic cylinders which are re-made using the “good” halves of condemned cylinders present a serious risk as they are rarely heat-treated after welding [46]. This was an issue in the Philippines until disposal procedures were tightened.

As at other stages of the LPG supply chain, illegal or unauthorized operations impede efforts to build a safe image of LPG and diminish the attractiveness of cooking LPG generally. In addition, such practices can prove to be major obstacles for corporations seeking to enter emerging markets with their products and services, exposing them to serious operational and reputational risks.

3. IMPROVING LPG SAFETY

At each stage of the LPG supply chain, different levers are available to mitigate safety risks, and different sector actors have a role in pushing those levers.

Several complementary approaches that can be adopted to improve safety along the LPG supply chain. They may be categorized as concerning the regulatory framework, training, education, and awareness, or new technology-based solutions. The first two approaches are largely the domain of the authorities, though the private sector can play an important role. The third is largely in the hands of LPG distributors or marketers, which are often privately owned.

The potential for each of these levers to enhance safety in developing countries varies according to the stage of the LPG supply chain (see Table 2 below). In general, regulation can have the greatest impact in ensuring the safety of equipment, LPG sourcing and

cylinder filling, refilling, and requalification. Education is important at all stages of the chain once the cylinder is in circulation. The greatest potential for new technologies to improve safety lies in equipment manufacturing, filling and refilling, home delivery and installation, and its use in cooking.

Each of these levers is described below and categorized as ‘major’—meaning the lever is critical to resolve the safety challenge, and ‘minor’—where these mitigation measures can play a non-critical but helpful role to improve LPG safety. This section assesses the principal emerging private-sector technological solutions and their potential for improving safety in developing countries based on surveys conducted.

Table 2 - Main mitigation levers per identified safety barrier by supply chain stage

Stage	Exact process involving potential safety barriers	Mitigation levers		
		Regulatory framework	Minor Training, education and awareness	Major Emerging technological solutions
A	Equipment manufacturing	✓	✓	✓
B	LPG sourcing	✓	✓	✓
C	LPG cylinder filling	✓	✓	✓
C	LPG cylinder distribution to retailers	✓	✓	-
C	LPG cylinder management by retailers	-	✓	✓
C D	Delivery and installation at end-customer home	✓	✓	✓
D	Cooking	✓	✓	✓
D	Storage and care of cooking equipment	✓	✓	✓
C D	Cylinder refill or replacement when empty	✓	✓	✓
E	Cylinder requalification or scrapping	✓	✓	✓

Regulatory frameworks

A strong and robust regulatory framework is crucial to ensure public safety, reassure consumers, and give the private sector confidence in its ability to generate adequate returns on investment. As stated in the report “Scaling LPG for cooking in developing markets: insights from Tanzania,” the government must enforce LPG regulations concerning ownership and operating practices throughout the distribution network that both ensure safety and enable and encourage the private sector to make ongoing investments, given that LPG cylinders and other equipment used in supply of fuel can be dangerous if not well maintained or managed [13].

The LPG business is generally regulated via national policies and laws. Whilst many parts of the LPG business generally fall under national energy and health and safety legislation, most countries have developed regulations specifically for LPG. Regulations often draw on international standards, which complement local and company-specific standards. For instance, for cylinder requalification, countries usually have their own inspection standards [47]. For example, in the Philippines, the local PNS 03-2-2014 standard is used; in Indonesia, there is a combination of local and international guidelines (SNI1452:2011-Indonesia National Standard to guide cylinder design and the ISO 10464:2004-Gas cylinders inspection and testing standard. In addition, LPG marketers, particularly large multi-national corporations often also apply their own standards, which are often stricter than the national standards or regulations [48].

Standards evolve constantly over time with changing attitudes to safety and the emergence of new technologies. For example, the Kenya Bureau of Standards launched a new standard for LPG smart metering in 2019 (KNWA 2885:2019) in collaboration with the company PayGo Energy [49].

Regulatory entities, certification agencies, and national LPG associations all need to play a role in the enforcement of LPG-related laws and regulations:

- » **Regulatory authorities:** In Kenya, for example, the Energy and Petroleum Regulatory Authority regulates, monitors and supervises the importation, refining, exportation, transportation, storage, and sale of petroleum and petroleum products [50].
- » **Licensing and certification agencies:** In South Africa, LPG installers are required to register under the SAQCCGas (South African Qualification & Certification Committee for Gas) to be able to operate, and a Certificate of Conformity (CoC) must be issued after completion of a gas installation [51].
- » **LPG industry associations:** National LPG associations, whose members generally include marketing companies, cylinder manufacturing and maintenance companies, government representatives, and consumer organizations, can contribute to regulation and policy formulation, promotion of fair competition, adoption of international safety standards, collection and dissemination of information, and education and training [52].

Policies and regulations governing the ownership of cylinders are of crucial importance to ensuring safe practices along the LPG cylinder supply chain.

Two LPG cylinder distribution models exist worldwide: the branded cylinder recirculation model (BCRM) and the customer-controlled cylinder model (CCCM). The BCRM has proven more successful, especially in early-stage markets (see the Alliance’s report on scaling LPG in developing countries), in large part because it is more compatible with safety practices. Under the BCRM, distributors and marketers are responsible for cylinder safety—including inspection, maintenance, and replacement—and refilling the

cylinders throughout their lifetimes. Under the CCCM, end users own the cylinders and bring them to filling stations to be refilled as needed, without regard to the brand. With CCCM, cylinders in circulation tend to become unsafe due to a lack of incentives for the re-filler to inspect and repair the cylinders, as well as a lack of clear rules and incentives for customers to have cylinders properly inspected and repaired [13]. For this reason, many countries have introduced or are in the process of introducing a requirement for the BCRM. For example, the Government of Ghana is currently transitioning as rapidly as possible from CCCM to BCRM to reduce deaths caused by LPG accidents and to attract investment to scale up its LPG industry [13] [53].

In practice, the establishment of a traditional regulatory regime for LPG distribution is not always effective in preventing accidents and ensuring safety, especially in the poorest developing countries:

- » **The regulatory framework is not always clear or stringent enough:** For example, In Nigeria, a review of downstream petroleum industry operations revealed the “limitations of the framework such as incoherent laws, overlaps, duplications, and conflicting regulatory functions” [55]. For example, there may be a lack of clarity between the roles of government ministries, and national petroleum corporations in the monitoring and enforcement of LPG safety regulations.
- » **A lack of a safety culture and poor enforcement of regulations:** According to the World LPG Association, the withdrawal of some of the larger multinational companies from the global LPG business over recent years has increased the need for enforcement of safety regulations, including heavy penalties for non-compliance [56]. For example, poor enforcement of illegal refillers not only damages the reputation of the sector, reducing customer demand, but also leads to below-market prices, reducing the ability of investors to achieve a return on investment.

Box 2 - Case study: regulatory changes to improve safety in the LPG industry

In 2019, the Kenyan government enacted new laws aimed at putting an end to illegal refilling by disbanding the LPG cylinder exchange pool that previously allowed up to 50 marketers to sell gas to end customers and led to a number of illicit cylinder refilling operations springing up. The aim is to protect consumers from accidents caused by damaged and faulty cylinders, which have been on the rise in the last decade. The reform allows oil marketing companies to get together and form a mutual LPG exchange agreement to enhance their access to the LPG cylinder market [54].

-
- » **Corruption and smuggling undermine safety regulations:** For instance, illicit cross-border activities in Thailand, mainly in the form of state-subsidized LPG being smuggled into Myanmar and Cambodia, have led to an increase in accidents involving cylinders [57] [58].
 - » **Budget constraints impede the development and enforcement of regulations:** In Kenya, setting up requalification centers or obtaining certification from official regulated entities can prove to be very expensive for certain organizations [59], even where distributors systematically comply with the national industry’s standards. In addition, governments and regulators often do not have adequate budget to properly enforce standards.

A study carried out by the World Bank in 2011 found that the downstream petroleum laws and general regulations governing the LPG sector in many developing countries are incomplete and often antiquated [48]. The study assessed the legal framework, industry and market structures and practices, supply arrangements and infrastructure, and pricing policies of 20 developing countries around the world to examine how LPG can contribute to reducing household energy poverty in developing countries. It found that regulations typically do not contain specific provisions for LPG. Very few countries have special regulations for LPG, though many have issued at least some national standards and/or formally adopted international or regional standards for quality control and protection of occupational health, safety, and environmental (HSE). International standards are often applied by the regulators and the industry as a matter of fact, but without having a formal legal basis. Whether the rules are really applied and enforced depends more on the institutional structures and capacities of the authorities than on the completeness and sophistication of the regulatory framework, as well as on the characteristics of the suppliers and distributors in each country. The subsidiaries of major international oil companies and well-organized local operators, privately or state-owned, tend to apply their own basic standards regardless of the mandates and efficiency of the applicable legislation in the country [48].

Training, education, and awareness

Engaging in education and awareness campaigns on how to handle LPG safely is essential to promote and spread impactful messages on best practices with regard to LPG for cooking. Such awareness raising and education can bring down accident rates substantially and eradicate misunderstandings and misconceptions about safety that continue to discourage households in many markets from switching to LPG [60] [61].

Box 3 - Non-exhaustive list of good practices for personnel working in the LPG industry supply chain [46]

At bulk distribution & storage phases:

- » **Training should include product safety and emergency response procedures;**
- » **Housekeeping should be undertaken regularly.**

At refilling plants:

- » **Having adequate parking space and good traffic flow for vehicles moving through the plant reduces the risk of a collision;**
- » **Cylinder-filling plants can be noisy facilities—it is important to protect the workforce from high noise levels for their health and to maintain good levels of concentration.**

At the requalification premises:

- » **Destroying beyond repair when scrapping cylinders.**

At the dealers’ and retailers’ level:

- » **Cylinders should be stored in well-ventilated and secure areas that have good access for emergency removal in the event of an incident.**

Set up service agreements to provide delivery of the cylinder and connection to the appliance if requested by the customer.

Box 4 - Non-exhaustive list of good practices for end customers with regard to LPG [63]

While receiving cylinders:

- » Cylinder should be checked for company seal & intact safety cap.

Transporting cylinders:

- » Cylinder should always be kept in upright position.

Before use:

- » The gas stove should be kept on a platform above the cylinder level;
- » Windows should remain open;
- » Kerosene or other stoves should not be kept on the floor where an LPG cylinder is in use.

While in use:

- » Match should be struck first, then burner knob opened;
- » Vessels should not be left unattended on burners in operation –the content may overflow, extinguishing the flame and causing gas leakage;

- » Clothes made of synthetic fibres (e.g. nylon, polyester) should not be worn while cooking.

After use:

- » Regulator knob should be kept in “off” position when the cylinder is not in use;
- » Cylinders should be stored out of children’s reach.

In case of leak suspicion:

- » Doors and windows should be opened for good ventilation;
- » Extinguish all flames, lamps, incense sticks, etc. should be extinguished;
- » Soapy water can be used to detect potential leakage on cylinder envelope or hose;
- » Electrical switches or appliances should not be operated in the room (telephone, fan, TV, etc.);
- » Regulator and burner knobs should not be closed in panic.

Personnel and customers in contact with LPG need to be provided with effective guidance, i.e. information, training, instruction, and supervision, so as to [62]:

- » Fully recognize and understand the safety risks in storing, transporting, handling, and using LPG;

- » Learn the measures required to mitigate those risks;
- » Know what to do in the event of an emergency.

Education can take many forms, but to be efficient, educational messages must be conveyed to all stakeholders involved at all stages of the LPG supply chain.

These messages can be conveyed through various entities:

- » **State-led campaigns:** For example, in Ghana, the government, as part of its efforts to reduce deforestation, embarked on an LPG promotion program in 1989 under the Ministry of Energy [64] aimed at improving LPG access via existing LPG distribution networks nationwide, to increase LPG safety awareness through educational campaigns, and to promote local manufacturing of LPG cylinders and accessories [65] [40].
- » **Corporate sector-led campaigns:** In Indonesia in 2007, the Ministry of Women’s Empowerment was tasked with preparing the consumer education component of the national program to convert domestic kerosene users to LPG for cooking. Pertamina, the national oil company, was given responsibility for implementing the program, including addressing consumer concerns relating to supply, cost, and safety through education and awareness campaigns throughout hundreds of cities and villages via television, radio, and newspapers [1].
- » **Industry association-led campaigns:** The Liquefied Petroleum Gas Safety Association of South Africa has launched several schemes to promote the safe use of LPG in the country covering the benefits and applications of LPG, the LPG distribution chain, safety aspects, and the applicable standards and regulations. The most significant challenges concern sub-standard cylinders, and unsafe cylinder refilling and storage practices, illegal retailers and refilling sites, and a lack of public education about LPG safety. Solutions to address these specific problems were developed [66].

Safety messages can also be conveyed through diverse communication media. Examples include:

- » **Radio:** “Safety: it’s in Your Hands,” a public awareness campaign run in Abu Dhabi (UAE) from 8 August to 29 August 2016 [67];
- » **Television:** In India, educational messages starring Bollywood celebrities being broadcast on national TV channels or streaming platforms have provided to be very effective [68];
- » **Newspapers:** There have been many newspaper campaigns about LPG safety in India, such as in Bengaluru in 2015 [69];
- » **Leaflets:** “LPG Cylinder Safety Tips” leaflets are available on NP Gas’ website (Trinidad and Tobago) [70];
- » **Digital media:** New digital communication tools, including social media (discussed in more detail in the next chapter).
- » **Door-to-door:** In Ghana, the National Petroleum Authority has begun a door-to-door campaign to educate businesses on the appropriate use of LPG cylinders at home.

In many cases, education campaigns such as these have met with limited success, partly because the resources deployed have been too limited. Both governments and LPG marketing companies can do much more to raise awareness about LPG safety using the internet, newspapers, television, and other media, as well as face-to-face demonstrations by retailers. [71] Illiteracy and problems with translating information documents in remote, poor areas remain important barriers to proper education on LPG safety. There can also be difficulties in ensuring the consistency of the message over time and updating recommendations where necessary.



Photo: Pertamina

4. ASSESSMENT OF TECHNOLOGY SOLUTIONS

Technical innovations to overcome safety issues, usually led by private-sector LPG distribution and marketing companies, can be an effective complementary approach to regulation and education/training.

Several innovative technologies are already emerging for LPG and hold the promise of reducing operating costs and increasing opportunities for investors, in addition to enhancing safety and various stages of the LPG cylinder supply chain. In most cases, these technologies are being pursued by private sector companies, in some cases with the explicit support of the authorities.

This section elaborates on some of the leading technologies currently under development by private sector companies that are starting to be used in LPG markets and that have potential for making a significant contribution to improving safety in developing countries.

Based on an industry survey conducted as part of the research for this report, eight types of innovative

technological solutions have been identified that are emerging in the market for LPG cylinders and that have potential to enhance safety in using the fuel for household cooking in the household. In this section, each technology solution is assessed, describing the technology, its safety benefits, the major actors behind the technology's development and commercialization, its current market status, its affordability, and its market potential. As noted in earlier sections, affordability is a key barrier for market development in developing countries. Therefore, these safety solutions must not significantly raise the price for customers in order to be adopted by developing market customers.

The following eight innovations have been identified as the main key safety innovations emerging in the sector.

Table 3 - Identified emerging private sector-led solutions

A. Equipment manufacturing	B. LPG sourcing	C. LPG cylinder filling & handing by retailers 1. Filling 2. Distribution to retailers 3. Management by retailers	D. End customer usage 1. Last-mile delivery and installation 2. Cooking and storage 3. Cylinder refilling or replacement when empty	E. Cylinder requalification or scrapping
Innovative solution	Safety improvements			Stage(s) in life cycle
1. Composite cylinders	Composite cylinders are lighter, explosion-proof, corrosion-free, provide higher mechanical resistance and are sometimes translucent (making gas level visible), enhancing safety as well as customer and end user experience.			A, C, D
2. Advanced cooking equipment	Advanced valves, hoses, and burners are pertinent examples of LPG safety improvements through innovation in LPG cooking equipment. For instance, new valve designs reducing leak hazards and new hoses demonstrating higher resistance to kinking, pressure, or crushing are appearing on the market.			A,D
3. Cylinder tracking systems	Innovative identification solutions such as QR codes and RFID improve the traceability of cylinders along their lifecycle. Recording data and enabling controlled access to it increases both the transparency and the reliability of critical processes such as LPG cylinder transportation, storage, and filling.			A, C1, D, E
4. Cylinder sensors	These innovative plugin devices measure gas level and automatically detect when cylinders are empty, then notify customers and retailers, so a timely and safe replacement can be scheduled. Additionally, some sensors allow real-time monitoring of gas consumption and alert end customers when potential gas leaks are detected.			D2
5. Home delivery solutions*	Cylinders are delivered directly to households and installed, replaced, and refilled on a home-care basis, strengthening trust bonds between distributors and customers, while facilitating the diffusion of tailored educational messages for best practices in LPG cooking.			C1, D1, D3
6. Smart metering*	Smart meters take the form of smart valves that allow end customers to keep track of their exact gas consumption and pay through mobile money for small volumes of LPG according to their needs, in the broader context of Pay-As-You-Cook (PAYC) models. Their benefits reside in overcoming the upfront cost barrier while granting remote control on the device and its output.			C1, D
7. LPG leak detection systems	Standalone systems installed at facilities and homes, they detect leaks and trigger emergency procedures in the absence of systematic effective preventive measures such as odourising gas.			C1, C3, D
8. Innovative media to educate customers	Internet access and mobile phone penetration are changing the way LPG distributors can interact with end customers in developing countries. More and more, meetings and demonstrations within rural communities give prominence to proximity and trust building, turning commercial campaigns into powerful means to raise awareness on LPG safety.			A, C, D, E

*Technologies and innovations that are often enabling of being integrated in the "Pay-As-You-Cook" business model

For each solution, the assessment is summarized graphically according to three criteria (see Figure 5 below):









- » **Market maturity:** Level of uptake by the market as of 2019;
 - » High market maturity typically means tens of millions of households have access to this technology in the developing world.
 - » Medium market maturity means hundreds of thousands of households to single-digit millions are using the technology.
 - » Low market maturity means tens of thousands of customers are using the technology.
- » Given lack of centralized data on this subject, these estimates are based on feedback from experts and the experience of this report's authors.

- » **Affordability:** Added cost of innovation and impact on overall customer price of LPG;
 - » High affordability means the technology only adds a maximum of US\$2-3 per household.
 - » Medium affordability means the technology adds US\$3-20 per household, but still less than the typical price of a 6kg cylinder + first refill.
 - » Low affordability means the technology costs more than US\$20 or more, representing a large expenditure for the buyer or seller compared to the cost of a refill

Given confidentiality, these prices are based on feedback from experts and the experience of this report's authors.



- » **Safety benefits:** How impactful is the innovation in terms of safety improvement? High, medium, and low rankings are based on expert feedback and the technologies' ability to match safety challenges. It is important to note that many of these technologies are in their infancy so do not yet have robust data to examine how much they reduce accidents.

Figure 5 - Template used for assessment of the eight innovations' potential

Market dynamics	Affordability	Safety benefits
 High	 High	 High
 Medium	 Medium	 Medium
 Low	 Low	 Low

Composite cylinders

Stage(s) in life cycle

 A	Equipment manufacturing
 C	Cylinder management in the supply chain
 D	End-customer usage

Summary

Composite cylinders can address several safety barriers. Most importantly, they are explosion-proof, less susceptible to corrosion, and are lightweight, reducing the risk of damage and potential leaks. However, the higher cost of these cylinders compared to typical steel cylinders is likely to constrain their uptake in developing countries.

Description of the technology

Composite cylinders commonly refer to fiber reinforced plastic (FRP) cylinders. The term "composite" is used to indicate the manufacturing process involved, which is the macroscopic combination of two or



22-pound LPG composite cylinders

more materials to achieve superior properties [72]. The most common type of fiber used for composite cylinder is glass fiber, known for its affordability, high tensile strength, chemical resistance, and insulating properties [72].

A typical composite cylinder is made of two basic building blocks:

1. An outer layer which serves as a protection, including a hardened plastic cage and occasionally an aluminum ring [73].

2. An inner layer consisting in a matrix of fibrous laminates [74]. Resin and chemicals are often added to the composite fibers [75].

The estimated lifespan of composite cylinder is 15 to 25 years [76]. They are generally designed to withstand minimum level of physical impacts during handling and logistics. The strength and durability of composite cylinders are sometimes further improved by stacking different types of thicker, multi-layer fibers and protective casings [77].

Figure 6 - Focused schematic view of a composite (FRP) LPG cylinder [76]

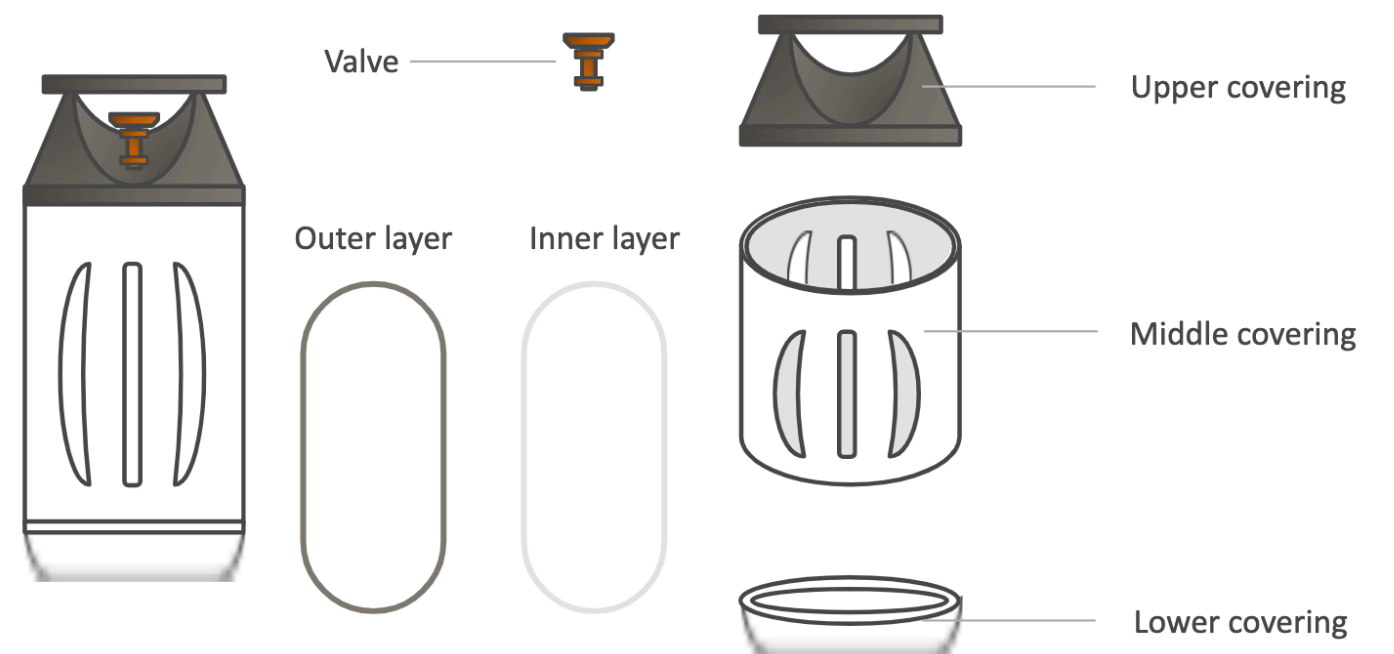

Safety compared to existing technologies

The main safety advantage of composite cylinders compared to traditional steel cylinders is that they are explosion-proof [74]. Composite cylinders, thanks to their leak-before-fail design approach, can never explode. When exposed to direct flames, the cylinder lining will be pierced, ejecting a plume of fire with the gas venting out from a hole, but there can be no BLEVE, even if the valve fails to work properly [79].

Composite cylinders offer other important safety benefits:

- » **Composite cylinders are lightweight** [76]. The new materials involved in their composition allows composite cylinders to be 50% to 70% lighter than traditional steel cylinders [72] [74] [77] [80]. Composite cylinders are thus easier to carry around and less likely to cause accidents in relation with manual lifting, with their modern design providing a better grip [77].
- » **Composite cylinders are translucent** [74]. The semi-transparent wall allows consumers to see the level of LPG remaining inside the cylinder [80] [76]. This design means users can easily keep track of their gas consumption (without any additional device or sensor to monitor gas level [77]) and facilitates the detection of suspicious falls in the volume in the container, which may indicate a leak. In addition, at the point of sale, under-filled cylinders, which can signal illegal practices, are more obviously and directly spotted.
- » **Composite cylinders can achieve a high strength-weight ratio and be more resistant to shocks**, thanks to the light, yet tensile structure of the laminate formed by stacking multiple layers of integrated glass fiber arranged in different directions [72].

» **Composite cylinders are not subject to corrosion** [76]. Composite cylinders are inherently resistant to damping, rusting, and corrosion, improving their resistance in particularly humid environments in comparison with conventional steel cylinders. In addition, composite cylinders can be resistant to ultraviolet (UV) rays. For example, the outer casing of composite cylinders made by Time Technoplast is made “by adding by adding UV protective additives so as to withstand adverse weather conditions and prevent degradation” [75], while “special adhesives prevent product degradation over time” on Rubis’ products [81].

» **Composite cylinders are easier and safer to transport** [82]. Their shape lends them to convenient stacking during transport, and whilst storing them at distributors, reducing the risk of damage.

Leading developers and marketers of the solution

A market study on composite LPG cylinders published in November 2019 listed the following manufacturers as key companies [83]: Hexagon Ragasco (Norway), Aburi Composites (UK), Time Technoplast (India), Santek (Belgium), Rubis Caribbean (Barbados), Supreme (India), Composite Scandinavia (Sweden), Gavenplast (Venezuela), Rad Sane Hidaj (Iran), Sundarban Industrial Complex (Bangladesh), Kolos (Bulgaria), Metal Mate (Thailand), and EVAS (Turkey).

Potential barriers to scaled-up adoption of the solution

According to a study published in 2013 in the IOSR Journal of Mechanical and Civil Engineering, the high cost of raw materials and fabrication [72] is the main disadvantage of composite cylinders. The added cost makes them less affordable for the general public.

Composite cylinders are typically double the price of usual cylinders. As a 2016 report on bottled gas as

household energy stated [77]: “Even in a country as wealthy as Saudi Arabia, they were introduced only in July 2010 at more than double the price of regular cylinders; 350 riyals (US\$93) compared to 150 riyals (US\$40)” [112]. The higher cost of composite cylinders has held back their use around the world.

In addition, the safety of composite cylinders is not necessarily improved to a significant degree. In case of fire, the structure can rapidly be weakened or even melt due to the surrounding heat, leading to potentially dangerous leakages [73]. This is particularly the case for lower quality, more affordable composite cylinders.

Furthermore, the reuse and disposal of such cylinders is also thought to be difficult [72]. This has dissuaded some LPG distributors, even in wealthy countries, from giving up steel cylinders for composite ones.

Current market landscape of the solution









The global population of composite cylinders is assessed at a few tens of millions. Hexagon Ragasco, the world leader, had sold approximately 16 million as of December 2019 [84]. This compares with an estimated 2 billion conventional LPG cylinders in circulation globally.

In Nepal, as shown below, the cost of composite cylinders has shown slow growth in the LPG for cooking market. In February 2018, the Nepal LPG Industries Association reported that the demand of composite LPG cylinders had been weak in the country due to the high price of composite cylinders, though such cylinders are believed to be much safer than the metallic LPG cylinders. According to The Himalayan Times, the government had allowed traders to introduce such LPG cylinders in the market in 2017, in a bid to curb the risk of explosion that is prevalent in metallic LPG cylinders currently in use [85]. Only 1,000 composite cylinders were purchased in the first eight months of the initiative.

However, in Bangladesh the recent roll-out of composite cylinders has been more convincing, as underlined by Hexagon Ragasco in their Annual Report 2018: after a successful launch and test period in 2017, the company has received repeated orders from existing customers in the region throughout 2018. Beximco, the company’s local distributor, ramped up sales and marketing significantly during the year and gained significant market share for composite cylinders in this market [86].



Summary of adoption potential in developing countries

Figure 7 - Assessment of composite cylinders’ potential for developing markets

Market dynamics	Affordability	Safety benefits
 High	 High	 High
 Medium	 Medium	 Medium
 Low	 Low	 Low

Advanced cooking equipment

Stage(s) in life cycle

	Equipment manufacturing
	End-customer usage

Summary

Substandard, ill-adapted, or worn out cooking appliances—primarily stoves, burners, valves, and hoses—are a far more common cause of household accidents involving LPG than a faulty cylinder.

In general, new products and appliances coming onto the market today have better design, are made with newer materials, or are just simpler to use, resulting in enhanced quality, efficiency, and safety. Advanced

cooking equipment allows a more secure injection of LPG from the cylinder to the cookstove, where a cleaner and safer combustion process will take place. Additionally, their cost is not necessarily much higher than that of classic products.

Description of the technology

We focus here on three examples of new technologies developed for key components of LPG cooking systems, i.e. components that are critical to safe cooking practices: LPG cylinder valves, LPG hoses, and LPG burners.

» **Advanced valves:** For example, the Double Spindle Valve System (DSVS) developed by Bright Gas, the LPG distribution company of Pertamina – the second-largest crude oil producer in Indonesia [87] – is a double-valve technology equipping the company’s new 3 kg fuchsia pink non-subsidized LPG cylinders [88]. On top of a conventional safety relief valve, the DSVS technology adds another level of security: if one valve is leaking, the second one is still able to keep the gas from escaping. The valve is equipped with a handwheel at the top. -

» **Reinforced hoses:** These are hoses comprising a tubular body of flexible material arranged between an inner and outer helically wound wire made of metallic material such as stainless

Figure 8 - Schematic view of a double spindler valve system

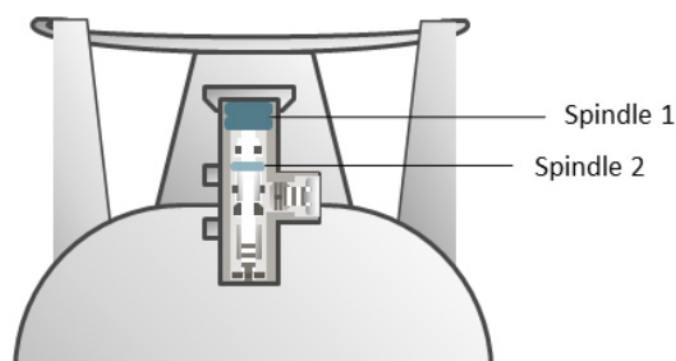

steel, aluminum, or a composite of reinforcing fibers such as carbon, glass, or polymers [90]. In India, the Suraksha hose, which is patented and manufactured by the LPG Equipment Research Center, Bengaluru, has three layers. The inner and outer layers are made of special quality rubber and the middle layer is made of braided copper or brass-coated high carbon steel wire mesh [91].

Figure 9 - Schematic view of a reinforced LPG hose



» **Infrared burners:** These burners incorporate an infrared head, which is a circular device attached around the burner under the pot to convert a part of heat released from the burner into infrared radiation that heats the pot bottom [93].



Examples of an infrared LPG cooking system

Safety compared to existing technologies

» **Advanced valves** are significantly safer than first generation, one-spindle valves. The packing design provides greater seal integrity than other packed valves and the sealing mechanism in this valve is designed to seal with only hand force. The diameter of the lower spindle is also much smaller than that of other designs of packed valves. The lower spindle connects to the upper spindle via a slip joint. In these valves, the lower spindle tip seals against the seat without rotating. This reduces some of the wear and buildup of particles compared with wrench-operated designs. The sealing motion and a considerable reduction in seat size allow this valve to be operated using hand torque. The packing nut of the valve is secured by a lock nut with left-handed threads, which prevents accidental loosening of the packing nut [95].

» **Reinforced hoses** are more resistant to the fatigue caused by repeated flexing and are therefore more durable and less likely to suffer cracks leading to gas leaks [90]. The outer layer is fire resistant and cannot be damaged by rodents or insects [91].

» **Infrared burners** operate at extremely high temperatures and achieve far higher thermal efficiency levels (up to 69%). As a result, the gas is almost completely combusted, which results in low production of toxic gases such as carbon monoxide (0.002%) and nitric oxide (0.0015%). And since infrared burners do not use open flame, they can be considerably safer in terms of burn risks [96]. A further benefit is that cooking time can be significantly reduced and cooking expenses reduced. Users can enjoy energy savings of up to 37% compared to regular gas stoves.

Leading developers and marketers of the solution

These technological advancements are often proposed by engineering groups addressing different

markets. Below is a non-exhaustive list of developers and markets for the three solutions highlighted:

- » **Advanced valves:** Pertamina Bright Gas (Indonesia), Cavagna Group (Italy), and Rotarex (Luxembourg)
- » **Reinforced hoses:** Suraksha (India), Trelleborg (Sweden), Namokar Entreprises (India), Parker (USA), and Dixon (Australia)
- » **Infrared burners:** Aoyang (China), Super Genic (Philippines), HomeCare (UK), Miaotai Electrical Appliance (China), Union Chen Industrial Corp. (China), and Sanford (Japan)

Potential barriers to scaled-up adoption of the solution

While infrared burners are still a niche product and too expensive for developing country markets, reinforced hoses and advanced valves are not too expensive, and their generalization largely depends on the adoption of specific standards by emerging countries, together with the establishment of cost-effective supply-chains. In India, a three-inch Suraksha LPG hose can be bought for less than US\$1 (Rs 55) [97]. Pertamina’s new cylinder featuring the “Double Spindle Valve System” was initially commercialized for US\$4.5 to US\$5.5 (Rp62,000 to Rp75,000) in its 5.5 kg (12.6 kg in total) version, depending on the point of sale [98]. On the other hand, Super Genic’s Infrared LPG stove was sold at a market price of US\$45 (₱2,295) in the Philippines [99].

Current market landscape of the solution

Safer hoses are starting to be deployed widely in many developing countries. In India, to ensure safety at home, the orange-colored Suraksha hose was made mandatory for the domestic use of LPG cylinders in 2015. The hose was only recommended as a product demonstrating key safety features and conforming to standards. The Ministry of Oil and Petroleum, at the time, stated that it would help improve safety at homes



Photo: Kip Patrick/Clean Cooking Alliance

and that end customers would not be permitted to use the former green rubber hoses anymore. Also, dealers were asked to make the necessary checks at homes when refills are supplied [91].

Summary of adoption potential in developing countries

Figure 10 - Assessment of advanced cooking equipment's potential for developing markets

Market dynamics	Affordability	Safety benefits
High	High [Hoses]	High
Medium	Medium [Valves]	Medium
Low	Low [Burners]	Low

Cylinder tracking systems

Stage(s) in life cycle

A	Equipment manufacturing
C	Cylinder management in the supply chain
D	End-customer usage
E	Cylinder requalification or scrapping

Summary

Historically, LPG cylinder identification and processing relied on hand-written paperwork, visual inspection, and manual verification. However, different types

of cylinder activity tracking techniques such as QR codes are emerging across the world. They allow operators to monitor and capture key cylinder data indicators, recording each movement and transaction from the day they are manufactured until they are scrapped. Data collected by the system allows stakeholders to know that cylinders were properly filled and maintained and improve decision making in the distribution process. [100]

Tracking improves the identification of damaged cylinders and discourages unregulated and illegal activities, contributing to safer practices along the cylinder supply chain.

Description of the technology

Tracking systems refer to systems that can:

- » Store key cylinder data: Weight, status (filled or empty), manufacturing date, maintenance history, past deliveries history, rotation ratio condition, and current condition (if fit for filling or use) [101] [102];
- » Provide access to this key data: Any operator, retailer, distributor, refiller, or even end customer equipped with the relevant scanning device can obtain the data.

The main function of tracking systems is that they connect physical material flow with information systems [103]. Some of the most common tracking systems include Barcode, Quick Response code (or QR code), and Radio-Frequency Identification (RFID).

Table 4 - Comparison between barcode, QR code and RFID [104] [105] [106] [107] [108] [109]



	Barcode	QR-code	RFID
			
Basic description	1D code consisting in vertical black lines of different width	An expansion of barcodes, where both vertical and horizontal placement of black dots form the code hence their other designations as 2D barcodes or matrix codes	A system using radio waves to transmit information stored in RFID tags-which are basically tiny radio transponders
Information access	Scanned by special optical scanners, called barcode readers	Read or deconstructed using application software on mobile devices with inbuilt cameras, such as smartphones	Digital data is transmitted when the tag is triggered by an electromagnetic interrogation pulse from a nearby RFID reader device
Read range	Several centimeters to half a meter	Several centimeters to half a meter	- Active: up to 10 meters - Passive: up to 30 meters
Data updating	Impossible	Possible via specific applications	Possible and often automatic
Information capacity	Limited (less than 100 characters)	- Alphanumeric: up to 4,296 characters - Numeric: up to 7,089 characters	Approximately 4 million characters
Longevity	Limited	Limited, but with a 7-30% error margin for reading	Less likely to be damaged or to wear off because of ambient conditions or friction

Table 5 - New features of barcode, QR code and RFID [104] [105] [111] [106] [107] [108]

	Barcode	QR-code	RFID
Data Security	Low	Medium (with token to be issued to clients for verification)	High (data can be concealed in a code and tags can be password protected)
Automation	Low (manual scanning required)	Low (manual scanning required)	High (fixed scanners without manual operation, also capable of reading multiple tags at once)
Tag cost	US\$0.01	US\$0.05	Up to US\$1

A unique tag—barcode, QR-code, or RFID tag—is given to each cylinder at the manufacturing stage. Critical data is then captured and documented (when possible) on the tags at every important stage along the value chain. The data follows each cylinder throughout its lifetime and can be accessed respectively with a scanner, a camera, or a RFID reader at any moment.

To strengthen the reliability of such systems, the serial number of a cylinder can be used to generate both a barcode and a QR code. This avoids duplication or interchanging of tags. In addition, customers can scan with their smartphones while operators and truck loaders can use optical scanners [108].

Safety compared to existing technologies

Compared with conventional means of cylinder identification, tracking systems using codes improve the transparency of LPG cylinder management and the reliability of verification processes, while also bringing operating costs down.

- » **More transparency in the supply chain:** Personnel can scan cylinders at any moment to review and update their condition at manufacturing factories, refilling stations, storage warehouses, or retail stores [111]. Easy but protected access to data by stakeholders strengthens validation processes and helps eradicate illegal or unregulated LPG activities. Scanning instantly identifies cylinders with missing or outdated data allowing operating personnel to easily spot and segregate “suspicious” cylinders. Finally, a

holistic tracking process diminishes the chances of losing or misplacing cylinders, which in turns prevent theft and loss of cylinders. It is estimated that 10-40% of LPG cylinders go missing every year around the world (WLPGA (The World LPG Association), 2019).

- » **More reliable verification processes:** For the coded systems to bring efficiency in the supply chain, rigorous procedures need to be followed through. Avoiding manual data reading and entry also brings more reliability and consistency in the process, while improved design of RFID tags increases the reliability of identification tags to record the data. Labels must be able to withstand rough handling and be resistant to fading in UV light, cleaning solvent, and chemicals (oil, grease, solvents, caustic cleaners, and acids), extreme temperatures, and humidity [112].
- » **Cost-effectiveness and lower accident rates through more automation:** Automated processes along the supply chain can reduce risks related to manual handling of cylinders [113]. Unloading and loading of cylinders from trucks repeatedly when receiving or dispatching orders for example can be skipped by fixing RFID readers at the entrance gate to automatically identify multiple cylinders when trucks pass through. Cylinders can be automatically ejected on the conveyor belt when found to be defective for requalification for instance [138]. Automation can bring other benefits. A considerable amount of time and labor needed for cylinder handling can be saved

[136]. In addition, advanced tracking technologies such as RFID can collect more data, including geographical data, which further enhances distributors’ control over assets [114].

Leading developers and marketers of the solution

Most of the major players offering LPG cylinder tracking systems are asset tracking solution providers catering for many other industries. They include Trovan (UK), TRAKAID (USA and India), and TrackAbout (USA). These businesses tailor their services for LPG marketers and distributors.

Potential barriers to scaled-up adoption of the solution

Capital costs are the key obstacle to the widespread deployment of tracking systems in developing countries. Apart from the tags that need to be bought, additional equipment, management infrastructure, and software applications are also required to set up a fully integrated system. Implementation costs vary depending on operational volumes, the type of tags and the specific functions required [115]. For instance, RFID readers can cost up to US\$3,000, while barcode scanner prices range from US\$400 to US\$600 per unit. Workforce training, tag labelling and subscription fees need to be added to the reading devices’ costs throughout the supply chain, ending in substantial overall technology cost per cylinder.

While asset tracking is widely practiced in other industrial sectors, the benefits of asset control to companies’ bottom line have not always been adequately demonstrated in the LPG industry as of yet [116].

Lastly, a prerequisite for the adoption of tracking technologies at the customer end is the affordability of smartphones and Internet services, as well as access to affordable electricity. This is still a challenge in many remote rural areas of Sub-Saharan Africa.

Current market landscape of the solution

Tracking systems rather attract the more mature LPG bulk transportation actors, with some companies currently equipped with their own cylinder management system [117].

It is anticipated that more companies will integrate RFID tracking technology to their operations in the next five years as they realize the potential efficiency gains and cost savings brought by automated tracking systems [116].

In less mature LPG markets, decreasing development costs and more intense promotion efforts on less-advanced technologies such as barcodes and QR codes should boost future demand for these systems in developing countries [114]. For instance, in Kenya, a pilot demonstrated that cost-effective tracking was achievable through QR codes printed on aluminum tags placed next to the valve of cylinder, as customers did not need any specialized equipment to access data, but only their smartphones [106]. Businesses in Kenya such as Proto Energy are already using QR codes, and in 2019, the Kenyan Government made tracking systems obligatory: “Every brand owner shall track cylinders by use of Radio Frequency Identification or QR code or any other appropriate technology” [118].

Summary of adoption potential in developing countries

Figure 11 - Assessment of cylinder tracking systems’ potential in developing markets

Market dynamics	Affordability	Safety benefits
High	High	High
Medium	Medium	Medium
Low	Low	Low



Photo: Circle Gas

Cylinder sensors

Stage(s) in life cycle

D	End-customer usage
----------	--------------------

Summary

Cylinder gas sensors are connected devices attached to conventional LPG cylinders to measure the level of gas remotely. The information obtained by the device is then transmitted to other devices such as smart phones or to data centers via the internet.

The primary objective of level sensing is to automatically detect and notify the owner and the user of the cylinder when it is empty, so it can be replaced with a filled one, with timely delivery and installation by the distributor. Additionally, some sensors allow real-time monitoring of gas level and notify end customers when a potential gas leak is detected as a result of irregular and sudden changes in gas level. They can also reduce operational risks due to incorrect filling practices.

Description of the technology

Gas level detecting devices are currently being developed based on an array of physical principles: mechanical, electrical, electromagnetic, optical, and ultrasonic [119]. Various designs are also available depending on the final application. Typically, two types of uses are distinguished:

Table 6 - Types and functionality of sensors

	Threshold-based sensors	Real-time sensors
Sensing of change in cylinder	Change in pressure (notification when nearly empty or completely empty)	Change in volume (continuous measurement)
Data sharing	Once a week	15-minute interval
Installation	Usually by professionals	Usually by the customers themselves
Gas leak detection	Not applicable	Yes

» **Threshold-based sensors notify the customer or the dealer when a cylinder needs to be replaced.** A hardware system is installed to periodically monitor pressure changes in the cylinder and then transmits data through the mobile telecommunications network to the cloud. Remote monitoring is achieved through visualization on an online portal. Access to this portal can be shared by the vendors with the end customers. Under normal operation, users would be provided with an update on the gas level once a day or a week.

» **This type of sensor is typically installed on cylinders that are used in parallel,** so that when the first one runs out of gas, supply is automatically switched to a second cylinder. A signal is simultaneously sent to the user and the vendor to schedule the next delivery.

Real-time sensors provide precise and live data related to gas consumption. The measuring device is typically attached by a magnet to the middle of the base of the cylinder with a supporting platform to provide adequate space between the foot ring and the ground or other flat surface.

When the cylinder is in upright position on a flat surface, the device uses an ultrasonic signal to measure the fill height and hence calculate the gas level [121]. Monitoring can be carried out automatically throughout the day. Some devices communicate directly to both the distributor and the end customer by sending signals through Bluetooth or the Internet on smartphone applications. For instance, the sensor marketed by YonkeGas automatically sends data every 30 minutes. A red light flashes when the volume of gas falls below 10% of cylinder capacity [122].

Figure 12 - Schematic of a real-time gas sensor, placed under an LPG cylinder

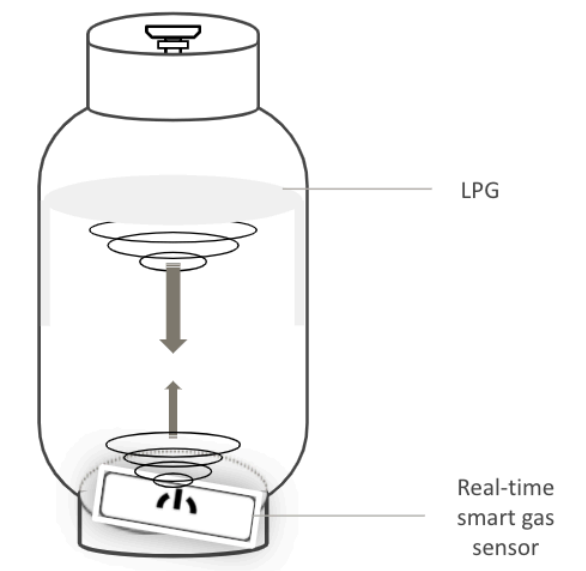
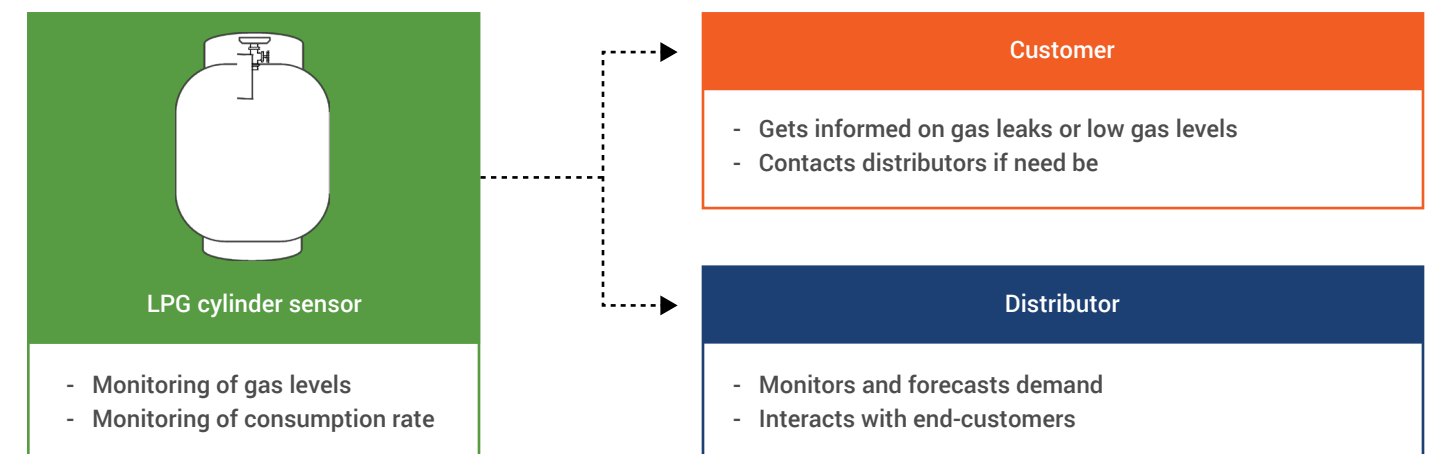

Figure 13 - Main advantages of cylinder sensors for involved stakeholders



Safety compared to existing technologies

Real-time sensors can provide direct safety benefits by detecting and alerting cylinder vendors and end users to gas leaks, reducing the risk of accidents.

Both types of sensor enable LPG marketers to have a greater degree of control over their LPG cylinders and to improve the efficiency and reliability of their logistics systems, as they can predict more accurately when and where deliveries should be made as well as the exact amount of LPG needed. By streamlining logistics, sensors can reduce risks inherent in the distribution of LPG cylinders by avoiding inefficient or unnecessary transportation of excessive amounts of LPG (Interview Sensile Technology). Moreover, scheduled delivery followed by professional installation and safety checks at point-of-sale leave less room for human error and fraudulent activities.

The more widespread use of sensor systems is expected to increase end customers' confidence in LPG services and use, as they can verify the state of the cylinder they purchased in real time. By offering customers the opportunity to check the gas level of the cylinder, customers are reassured that it was filled properly and that no leaks are occurring [122]. The ability and habit to monitor changes in gas level on their own indirectly raises the safety awareness of customers.

Leading developers and marketers of the solution

A number of systems with different designs and based on a vast range of technologies have already been introduced in mature markets. Leading providers of such systems include Truma (Germany), Smart Cylinders (Norway), Senso4 (Slovenia), and Mopeka (New Zealand). Some regional players, such as Nupe Design (Nigeria) and YonkeGas (South Africa) are developing and seeking to commercialize their own technology.

Potential barriers to scaled-up adoption of the solution

As for any additional device using advanced technology, affordability is the major barrier to widespread use of LPG cylinder connected sensors, especially in poor rural areas. In the absence of subsidies, the added cost of the technology ultimately has to be borne by the end customer, as gas sensor solutions are usually marketed as an ancillary item for household LPG cooking systems [126]. Devices offering real-time monitoring or higher accuracy on remaining gas volume are likely to prove too costly for most households, with systems costing more than the cost of the cylinder.

Further technological breakthroughs and changes in design are needed to realize the potential of gas level sensing solutions, such as:

- » **Improved battery performance:** Sensors are typically powered by battery, and frequent monitoring can drain the battery rapidly. Limiting the transmission frequency to one daily occurrence could extend battery life to up to seven years (real-time sensing device batteries last no more than three months [124] [120] [122]).
- » **Speed and quality of data transmission:** Developments are possible to improve the efficiency of data transmission from the device to the internet, or to achieve longer wireless ranges, especially in places where telecommunications infrastructure is not 100% reliable.
- » **Universality of design/adaptability:** A large proportion of wireless real-time sensors can only be used with specific types of LPG cylinders. For example, Trauma's LevelControl device is designed to be used exclusively on steel or aluminum gas cylinders with a diameter of 200 to 350mm [121].









The correct installation and appropriate use of real-time gas sensors relies greatly on customers, who may not always be ready to make proper use of the technology and profit from its safety benefits. As an example, since most volume sensing devices need to be placed below the cylinder, incorrect initialization can lead to inaccurate data on gas levels or accidents caused by mishandling of cylinders by the customers. Precise steps are usually required to set up the sensor, notably pairing up the wireless monitor to the customer's smartphone [122] [121].

Current market landscape of the solution

- » **Threshold-based sensors** are likely to hold more potential in mature markets, where households can afford two-cylinder systems. For the time being, their use in developing countries is expected to be limited to bulk LPG storage tanks or transportation.
- » **Real-time sensors** are of more interest when it comes to detecting gas leaks and cutting logistics costs. Some companies are trying to provide such systems in emerging markets such as South Africa and Nigeria where there is a growing affluent class in urban areas and where demand for more sophisticated and connected products is rising. In South Africa, YonkeGas' standard sensor designed for regular steel LPG cylinder is sold at a price of US\$53 [122], which is still very high compared with the price of the cylinder. In Nigeria, NUPE's LPG smart scale is a pilot project seeking to monitor gas level through IoT solutions, connecting the device to a cloud platform with geolocation capabilities. In more mature markets such as Norway, the use of smart sensors is more widespread. The CEO of NorgesGass (Norway) thus considers that the rapid growth strategy of his company would not be possible to execute without the use of the Smart Cylinders system [127].



Summary of adoption potential in developing countries

Figure 14 - Assessment of cylinder sensors' potential in developing markets

Market dynamics	Affordability	Safety benefits
 High	 High	 High
 Medium	 Medium	 Medium
 Low	 Low	 Low

Home Delivery Solutions

Stage(s) in life cycle

	Cylinder management in the supply chain
	End-customer usage

Summary

Home delivery—the distribution of cylinders directly to the end customers' premises—means customers do not have to carry the product themselves and therefore reduces the risk of cylinders being damaged. When a properly trained delivery person also installs the LPG cylinder, risks of poor installation and malpractice are also lowered. The weight of a full LPG cylinder can exceed 25 kg, making customer collection an arduous task for domestic consumption in developing countries' rural areas, where private vehicle ownership is often very low. Home delivery is becoming increasingly common in the residential LPG sector in developing countries [39]. In Brazil, for example, most residential LPG is home-delivered, while 34% of urban customers and 21% of rural customers have LPG home delivery in Kenya.

Home delivery can be mutually beneficial for both the client and the buyer. Retention rates are generally higher for the marketer thanks to a tailor-made process

with regular interactions, while the customer enjoys a safer and effortless delivery service.

Description of the technology

Home delivery encourages higher LPG adoption by providing a better quality of service. It aims at saving customers' time and effort and can save money on transportation too if the cost of the service is less than the cost the customer would incur by collecting the cylinder himself when replacing an empty cylinder for a full one.

Orders are usually made by telephone to a centralized customer service center managed by the LPG distribution company. The cylinder is then delivered to the customer's home [39]. Generally, marketers advise customers to place an order before the cylinder is empty, as the delivery can take up to a few days or a week depending on location [128]. Customers may be asked to pay in advance (e.g. via mobile money) for their order or can pay on delivery.

Auto-ordering relies on smart technologies to monitor the gas level inside the cylinder. When it reaches a critical threshold, notifications are automatically sent to the distributor, triggering the scheduling of an LPG cylinder replacement according to the delay specified in the contract. As yet, auto-ordering is rare, even in mature markets.

In either case, the empty cylinder is removed and replaced with the full one. A trained installer may also carry out safety checks. In some places, the order is transmitted to contracted dealers covering the customer's location to handle the delivery [39].

As the use of smartphones and internet is rapidly growing, notably in East Africa, new actors are entering the market for home delivery services through mobile applications. The Vite-LPG app developed in Kenya is one example. Mr. Thangu—the CEO of Vite Kenya—and his team estimated that refills are needed approximately every three months in Nairobi County,

where 29% of residents are regular users of LPG [129]. The Vite-LPG app enables clients to arrange for home delivery by the nearest approved vendor in just a few clicks. A deliveryman then contacts the customer and replaces the cylinder in the shortest time possible, on average 80% faster than standard gas deliveries. In addition, the end customer is able to track the delivery in real-time via the app. The company ensures that the gas sold by the merchants is of high quality and that the cylinder is filled to capacity by vetting the suppliers that are signed up to the Vite platform [129].

Safety compared to existing technologies

Home delivery relieves end customers—most of the time women—from carrying cylinders, thereby reducing the risk of injury.

Having professionals taking care of deliveries also ensures that cylinders are transported safely in an upright position. Furthermore, these delivery men (or women) are responsible for the quality of service provided, whether they operate independently or as full-time employees.

Home delivery models allow marketers to know where their customers are, and, with them, their cylinders. This helps in tracking cylinders, especially in rural territories, and in eliminating illegal practices.

One key advantage offered by home deliveries is the possibility to convey safety messages actively, regularly, and with consistency over time. Safety tips and instructions can be transmitted by trained professionals, on top of safety checks when the cylinder is installed. Some companies even conduct regular safety audits for every cylinder and all equipment delivered to the homes and businesses of their customers [131].

Home delivery can reinforce the safety benefits of advanced metering equipment and sensors as it encourages customers to be alert to gas leaks. Where available, the use of smartphone apps to track deliveries

is another opportunity to send safety messages (see below) and provide information on maintenance status of the cylinders. However, it should be noted that delivery firms need to also apply strict safety measures. As noted in the previous chapter, unsafe transport of cylinders can lead to accidents.

Leading developers and marketers of the solution

There are a large number of distributors and independent delivery companies offering LPG cylinder home delivery services in many developing countries. Some delivery companies have established partnerships with leading distributors, while others are emerging in the context of Pay-As-You-Go (PAYG) offers (see below).

Potential barriers to scaled-up adoption of the solution

In developing countries, home delivery is still a challenge, particularly in rural areas, where population density is lower and distances between distribution points and local communities (small towns, villages, campsites) larger.

The absence of tarred roads connecting these villages with urban relay points and seasonal weather conditions affecting road infrastructure tend to make delivery even more difficult. On top of that, locating

customers in zones where the telecommunications network coverage is not guaranteed can be difficult.

Another problem is the development of fraudulent practices by dishonest delivery companies, which can discourage households from adopting LPG. It is important that delivery men wear uniforms to gain trust from customers. In India, marketers are also warning the public about the existence of fake, look-alike websites offering to book LPG delivery services and cheating customers [132].

For all these reasons, home delivery of LPG cylinders in less urbanized areas in emerging markets is often too complex and difficult to be financially viable. Additional operational costs are usually passed on the final customers, making the service less affordable. Kenya is a notable exception, where 21% of rural households use home delivery [134].

In urban centers though, where purchase power is higher on average and middle-class customers accustomed to delivery services for other types of products, the potential for LPG home delivery is much greater. In Northern Ghana, researchers asked both suppliers and household respondents to give their opinions on the potential effectiveness of different policies that could be implemented to increase adoption of LPG in the Kassena-Nankana Districts. Home delivery options for LPG fuel were seen as less effective than subsidies (for hardware and fuel), but the perceived effectiveness of home delivery in urban areas was higher than in rural areas [135].

Current market landscape of the solution

Home delivery is already well-established in many developing countries.

» **In Turkey**, home delivery and cylinder installation by technical professionals in customers' homes are both legal requirements [71], with high standards set for safety and quality of service in general.



Typical uniform worn by LPG cylinder delivery men in India

» **In India**, an initiative seeking to serve a majority of rural LPG consumers through home delivery was launched in 2016. The government issued an order mandating that all cooking gas distributors serving rural areas and with sales exceeding 1,500 refills a month provide home delivery of cylinders to their customers [136]. To date, all of about 5,500 dealers under Rajiv Gandhi Grameen LPG Vitran (RGGLV) scheme, a government program launched in 2009 to set up small size LPG distribution agencies [137], were exempt from making home deliveries of cylinders. The government order changed that for about 60% of RGGLV dealers [138]. Lower consumer concentration in villages and lesser demand—rural consumers usually consuming less cooking gas due to easy availability of cheaper substitutes—historically worked against the viability of rural dealerships, which is one reason why they were exempt from delivering cylinders to customers' homes. In urban areas, it is compulsory for all dealers to make home deliveries. Gas agencies usually charge Rs 20 (US\$0.28) for home delivery of an LPG cylinder. In places where home delivery is not available, customers usually spend Rs 100 (US\$1.40) or more in transport, and sometime have to forego their day's wage to fetch cylinders from distant warehouses [139].









» **In Kenya**, a program launched in October 2016, intended to subsidize the cost of cooking fuel for the poor within three years, especially in the rural areas. The government was to buy five million LPG cylinders by the end of 2019, fill them with gas and distribute them to the low and middle-income households at a reduced cost of Ksh2,000 (US\$20) [140]. The fee covered cylinder, burner, grill, gas, and home delivery. However, nearly all the initial 300,000 Yetu LPG cylinders delivered by Allied East Africa Ltd (AEAL)—the Kenyan business contracted to supply the government—became defective, resulting in the collapse of Project Mwananchi [141]. This example shows that finding the right partners

is key to successful LPG promotion initiatives, as unsafe practices and products will have a counter-productive effects.

In most developing countries, the widespread adoption of home delivery is still dependent on government-led policies and infrastructure.



Summary of adoption potential in developing countries

Figure 15 - Assessment of home delivery solutions' potential in developing markets

Market dynamics	Affordability	Safety benefits
 High	 High	 High
 Medium	 Medium	 Medium
 Low	 Low	 Low

Pay-As-You-Cook (smart metering)

Stage(s) in life cycle

 C	Cylinder management in the supply chain
 D	End-customer usage

Summary

By supplying LPG on a Pay-As-You-Go basis—the term Pay-As-You-Cook or PAYC being derived from the former expression and used to characterize similar models applied to cooking solutions—enterprises are leveraging technology-focused business models to overcome the affordability barrier previously faced by consumers unable to pay the upfront cost of household energy products [143]. Within this business model, LPG cooking systems belong to the company and customers solely pay for the gas. This maximizes marketers' control over the LPG system and minimizes misuse by the customer, improving safety.



KopaGas' LPG smart meter deployed in a Tanzanian home

The key underlying technology used by these PAYC systems is smart metering, which refers to smart valves giving customers access to gas only once payments are processed, hence enabling real-time remote monitoring of gas consumption.

Description of the technology

Key steps in Pay-As-You-Cook models

1. Customers sign up for the service, either directly in their hometown or village or through digital channels, and designated trained employees deliver and install a fully equipped LPG cooking system;
2. Guided by the agents, customers learn how to safely use and store the equipment;
3. They then proceed with their first payment, purchasing gas according to their needs (quantity needed for a meal, a day, or a week for instance) using mobile money;
4. The smart meter monitors the level of gas in the cylinder, extracting consumption data at 15-minute intervals throughout the day and

sending it to centralized servers for monitoring and analysis [144]. The close monitoring enables a timely delivery of refilled LPG cylinder while informing the customers on their gas-related expenses.

Smart metering process

Machine-to-machine connectivity provides a platform for communications between the customer's system and the company's servers [144]. Signals are exchanged in perfect autonomy, no intervention by customers or operators is required, provided that the Internet connection is strong enough. GPS-enabled smart valves provide precise geolocation data, thus facilitating the automatic scheduling of cylinder delivery [145].

Safety compared to existing technologies

- » **Smart meters** usually come with anti-tampering systems. Usually taking the form of plastic caps placed on the valve, these seals serve as an authentication of the LPG cylinder's origin and quality.

- » **Smart meters** generally employ technology that respects high-level technical standards. In Kenya, public and private sector stakeholders, including the Kenyan Bureau of Standards and the company PayGo Energy, launched a new standard for LPG metering, officially titled “Meter for dispensing liquefied petroleum gas (LPG) from cylinder” (KNWA 2885:2019). The standard is the first of its kind globally [49].
- » **PAYC models** allow for safer delivery and installation practices (see section on home delivery solutions above) by trained employees through a standardized and streamlined process.
- » **PAYC models** usually imply safety checks and teaching of best practices directly at the point of sale, namely customers’ home.
- » **PAYC models** facilitate the creation of a long-lasting relationship between the supplier and the customer, with dedicated after-sale service reachable through the mobile phone that is used to make payments, thus providing another communication channel for educating customers about safety (that can be made even more effective with mobile applications and smartphones—see section on innovative media for education below).

Potential barriers to scaled-up adoption of the solution

As was the case with PAYG access to solar-based electricity, PAYC actors need to demonstrate the robustness and economic viability of their model through large scale rollouts, so as to unlock private sector investments on top of public sector concessional loans and subsidies [150]. LPG prices are regulated in many countries, which means that LPG PAYC companies may not be able to offer their services at a high enough price to cover the additional upfront costs and generate adequate profit margins even if they offer consumer finance.

The affordability of such systems is still to be questioned when trying to address the cooking needs of hundreds of millions of people living beneath the poverty line. This was highlighted in 2019 in a report focusing on India, which highlighted the importance of reducing the cost of smart valves in deploying PAYC technologies more widely [151]. The smart valve required by LPG PAYC systems can cost more than the cylinder itself. KopaGas and LPG PAYC companies in other countries are working on new valve technologies with the aim of reducing its price [13].

Customer retention over time is another challenge for new PAYC models. LPG PAYC customers may decide to go back to the traditional way of purchasing LPG cylinder refills if the aggregate payments to PAYC over a year exceed those involved in paying for standard LPG refills for the same amount of cooking [13].

Current market landscape of the solution

Despite financial challenges, pilot projects in Africa have demonstrated that the potential of the technology to play a role in lowering the upfront cost of LPG cooking systems, which is the major barrier to LPG adoption by poor households:

- » PayGo Energy has been piloting a PAYC project in Nairobi, Kenya, since 2015 [117] and achieved

98% cylinder retention and 90% customer retention—86% of the customers being first-time LPG users.

- » KopaGas, in collaboration with Oryx Tanzania, completed a commercial pilot in Dar Es Salaam, Tanzania [154]. The results showed high customer satisfaction, better understanding of users over consumption, improved asset management, and a reduced need for cash management. The deposit payment amounts to US\$6.5, followed by daily payments of US\$0.3 [155]. Circle Gas bought the technology of KopaGas for in early 2020, a major investment for the clean cooking sector.
- » Envirofit’s pilot program, SmartGas, has received positive feedback with high referral rates for new users. Their customers’ average top-up amount is US\$1.6, for a quantity of gas equivalent to the needs for a couple of days [152].

New projects, launched by companies already active in the PAYG solar sphere in the developing world, are currently emerging, capitalizing on existing sales, distribution networks and customer bases [156]. BBOX Cook in Rwanda or Fumba, launched by Fenix International (part of Engie Group) in Uganda, are examples of such initiatives in East Africa [157].

Summary of adoption potential in developing countries

Figure 16 - Assessment of Pay-As-You-Cook (and smart metering) potential in developing countries

Market dynamics	Affordability	Safety benefits
High	High	High
Medium	Medium	Medium
Low	Low	Low

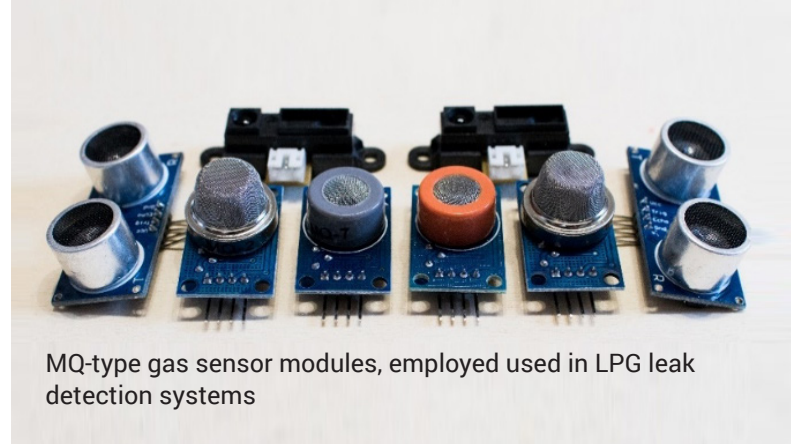

LPG leak detection systems

Stage(s) in life cycle

C	Cylinder management in the supply chain
D	End-customer usage

Summary

Leaks of LPG from cylinders, whether caused by faulty equipment or malpractice, in the home are a serious hazard, as they can lead to the buildup of the gas in confined spaces and the risk of explosion and fire. The main technique for aiding the detection of gas leaks is the odor injected into gas. However, some people with a reduced sense of smell or unfamiliar with the smell may not realize there is a leak. A gas leak detector—a device consisting of a gas sensor that monitors LPG concentration in ambient air and triggers an alarm when a specific threshold of gas density is exceeded—can be a more reliable solution [158].

Description of the technology

LPG leak detection systems are available in a wide range of products featuring different technological options to alert end users to leaks. Some devices are similar to smoke detectors and simply alert the end user through lights and sounds. More recent technologies use the Internet of Things to notify customers via mobile devices.

The technology behind all leak detection systems is gas sensors. The most commonly used sensor

is the MQ-6 sensor, a highly sensitive sensor that detects the presence of LPG in concentrations from 200 to 10,000 ppm (parts per million). It has an outer membrane coated with Tin Dioxide (SnO₂). The coating's conductivity increases along with the rising LPG concentration, changing the sensor's resistance and resulting in a different electrical voltage [159]. The corresponding pulse is fed to a microcontroller which processes the signal to obtain a digitized value. The digitized value serves as the output to alert the user [160]. The sensor is typically powered by a 12V DC source. Other detection technologies include hot wire semiconductors or catalytic combustion [161]. Depending on the type and model, detectors have different detection ranges and response times.

Standard LPG detectors consist of simple sensors connected to speakers, buzzers, or voice alarms that are activated in case of leak detection [163]. These detectors come in a compact handheld form or a stationary form (wall-mounted, just above floor level as LPG is heavier than air and so tends to accumulate on the ground).



Standard LPG leak detection system featuring visual and sound alarms

More advanced leak detectors incorporate GSM, Wi-Fi, or Bluetooth modules able to communicate with end users. These modules are connected to the Universal Asynchronous Receiver-Transmitter (UART) pin, embedded in the microcontroller and automatically send notifications, such as push notifications or a text message to a pre-configured phone number. This way, residential LPG users are notified of any gas leakage even when they are not at home [164].

More advanced LPG leak detectors incorporate smart sensors equipped with command and control units (CCU), which send instructions and carry out information-based tasks, asking actuators to execute the required procedures. Associated with additional connected devices, the sensors can shut off the gas supply by activating a solenoid valve and then evacuate the leaked gas by activating an exhaust fan [159]. Recently, IoT-based detection systems have been pushing the digitization one step further for industrial applications: using a cloud platform, smart alerts are sent through phone calls, smartphone app notifications or by sending emails to specific personnel (Soh, Abdullah, Shafie, & Ibrahim, 2019).

Safety compared to existing technologies

Automatic LPG leak detection systems are already being used in situations where the time-tested practice of gas odorizing is not applicable or not effective:

- » Odor-fading and under-odorization of LPG, due to substandard or illegal practices, sometimes explain why certain leaks remain undetected [167] [29].
- » In the upstream LPG is often handled in a non-odorized form, making gas leaks.
- » Some people will also become insensitive to the odor of the gas as a result of repeated exposure [168], or have physical disabilities preventing them from smelling the distinctive odor (most people describe the smell as either rotten eggs or rotten cabbage).

LPG leak detection systems do not rely on manual detection, which requires a certain level of education and training to raise end users' awareness. Existing precaution measures require customers to learn to notice indicative signs of leaks: the characteristic odor, a red or a yellow flame, scorching or soot, or even a hissing noise caused by the leak [169].

The simple act of installing a leak detection device is a step towards higher safety consciousness of the customer. Vibrant visual signals and loud alarms help emphasize the serious nature of a gas leak.

The possibility to receive alerts via notifications from connected systems also makes distance monitoring possible, so the home is kept safe even when the owner of the system is away.

Smart systems, programmed to automatically set off the response mechanisms and spontaneously neutralize the risk caused by a gas leak, are more adapted to industrial processes and professional environments, where they allow to prevent accidents even in the absence of specifically trained personnel.

Leading developers and marketers of the solution

There is a wide range of standard and connected LPG leak detection devices available in the market offering different functions, features and price ranges.

Some technology providers are regularly cited in online rankings based on customer reviews and identified as providing good quality domestic gas leak detectors [170]. The following are non-exhaustive lists:

- » Standard detectors: First Alert (USA), MTI Industries (USA), UEi Test Instruments (USA), Seitron (Italy), Supergas (India), Ourjob (China), and City Gas (Japan)
- » Advanced detector: Mesmart (China), Moes-House (China), Heiman (Germany), and Yao-sheng (China).

Potential barriers to scaled-up adoption of the solution

Just like other electronic devices presented in this report, leak detection system implementation incurs additional costs that could represent a major barrier to market expansion in developing countries. To buy a standard gas leak detector (featuring sound and light and/or voice alerts), a customer will have to spend at least US\$20 on online marketplaces [171].

Especially for more advanced detection systems, the installation costs for full systems are beyond the means of poor residential customers. In the context of LPG-related industrial facilities, the use of advanced stationary detection systems—with connections to multiple other systems—would require onerous infrastructure on-site modifications that owners may not agree to cover.

Moreover, connected devices hinge on the accessibility and affordability of smartphones and Internet-related services, which is still limited in the rural areas of the geographies put forward in this study.

Like any automated system, LPG leak detectors are only effective if customers have a proper understanding of how they function. User manuals may not be sufficient if not available in the right language or dialect. Additional training and involvement of all family members are required to ensure the system does not end up as a gadget.

Current market landscape of the solution

Domestic detection systems are readily available in most markets, often marketed as electronic household safety appliances. Most of the time, these devices not only detect the presence of LPG but are also capable of detecting the presence combustible and poisonous gases [172].

Basic LPG leak detection systems use relatively cheap components and numerous research papers



Photo: Wana Energy Solutions

explaining the working principles of such systems are publicly available, paving the way for new business opportunities in developing countries.

Overall, standard, unconnected leak detection systems can be found at reasonable prices but still represent a luxury for base-of-pyramid populations already making a considerable financial effort to switch to LPG-fueled cooking systems.

The widespread adoption of this solution could be encouraged by government policies and programs, in the same fashion as smoke detectors. Some developed countries such as Canada, Australia, or France have made smoke detectors a legal requirement in all homes and offices. In New Zealand, landlords are obliged to pay for installing smoke detectors in their properties [173].

The adoption of advanced detection systems linking multiple detectors and remote monitoring systems is likely to remain restricted to industrial applications or domestic applications for landlords, community buildings and student accommodation [172]. In the Philippines for instance, gas detectors were made mandatory in 2013 by the government, but solely in Bonifacio Global City, which is the only city to have a piped-in gas system in the country by design. The installation of gas detectors concerned all buildings and establishments connected to the Bonifacio Gas Corp, the business responsible for the supply of LPG [174].

Summary of adoption potential in developing countries

Figure 17 - Assessment of LPG leak detection systems' potential in developing countries

Market dynamics	Affordability	Safety benefits
High	High	High
Medium	Medium	Medium
Low	Low	Low

Innovative education media

Stage(s) in life cycle

A	Equipment manufacturing
C	Cylinder management in the supply chain
D	End-customer usage
E	Cylinder requalification or scrapping

Summary

Consumer education is an indispensable component of enhanced LPG safety awareness. Over the past several decades, education programs and awareness-raising campaigns have been implemented around the globe. Some successful cases have revolutionized

ways to reach customers on LPG safety and put forward the merits of utilizing innovative media to disseminate safety messages.

Delivering tips through digital “edutainment” (material intended to be both educational and entertaining), extends the accessibility and reach of safety messages while community meetings and gatherings reinforce trust through closer proximity. In addition, utilizing mobile phones to spread safety messages helps reduce the costs of reaching the mass market.

Description of the technology

Mobile applications, SMS, push notifications, social media (WhatsApp, Facebook, Twitter), and online digital content platforms (such as YouTube or Instagram) are used to deliver safety-focused messages that are less restricted by time and geography.

Mobile phones and online platforms (social media as well as specialized applications) can be used to convey powerful messages to a wide range of actors at low cost.

Digital media can also help with the organization of community meetings and cooking demonstrations which are proven to be an effective measure of passing LPG education messages. These education channels hinge on both the format of the meetings and the responsible agent’s ability to communicate safety messages. Among social groups, engaging women and children is also key to spreading safety messages [71] [176]. By creating social media events through platforms such as Facebook, and contacting people through communicating through platforms like WhatsApp, organization of these meetings is facilitated.

Safety compared to existing technologies

Compared to traditional channels such as television and radio broadcast, which only allow unidirectional communication, new technologies unlock the potential for interactive communications between retailers and

customers and even among customers, themselves.

Instant two-way communications are made possible by phones and the Internet, through customer support hotlines, or through social media platforms such as Facebook or WhatsApp. A few examples are found below:

- » **YouTube:** The Indian Oil Corporation Limited’s LPG safety film has been viewed more than 880,000 times. While in the Philippines, 2.6m people have viewed an LPG safety video for Petron Gasul, which also advertises home delivery in Manila.
- » **Twitter:** Petronas in Malaysia, TOTAL Kenya and Hindustan Petroleum in India have all actively used twitter to spread safety messages. TOTAL Kenya for example used Twitter for their #IfyousmellLPGinsideyourhome safety campaign.
- » **Facebook:** Panchakanya Group in Nepal has used Facebook to provide safety tips for their cylinders. Meanwhile, Bharat Industries used Twitter to spread its #safetyfirstsafetyfirst campaign.

No formal studies have been carried out on the effectiveness of these technologies, which would be an interesting path for future research.

These channels also allow customers to have their questions asked and answered rapidly, or even immediately, which is crucial to ensuring customer proactiveness and empowerment when dealing with LPG (takeaway from interviews with Emmy Wasirwa, Founder and Chief Executive Officer at Wana Energy Solutions in Uganda, interviewed on November 28, 2019).

A bottom-up communication approach also facilitates information sharing among users, who educate each other. Though television penetration can be limited in remote areas, a large majority of villagers own mobile phones. Push notifications or text messages sent to all registered customers in batches are another



Photo: KopaGas

example of how new technologies can be used to improve education on LPG safety without incurring significant marginal costs. In a recent program in Ghana, it was found that traditional media methods were not effective in ensuring continuity of messages when educating new users who have just switched to LPG cooking [178].

In addition, messages conveyed through pictures, videos, songs, podcasts, or even comics are advantageous in reaching populations with literacy barriers.

Leading developers and marketers of the solution

LPG marketers also conduct their own communication campaigns. Whether they are conducted in direct contact with populations or through virtual media, awareness campaigns are most often backed by national petroleum industry players in association with governments. At the moment, no advertising agency has been identified as running specific social media communication campaigns on behalf of LPG players. However, several distributors, such as the Indian Oil Corporation, Hindustan Petroleum, and Total Kenya all have used different social media channels.

Potential barriers to scaled-up adoption of the solution

The main barrier to wider use of digital technologies for educating households on LPG safety is access to electricity and cellular networks. 3G and 4G Internet coverage in rural areas – where the need to switch to LPG for cooking is greatest – is generally far less developed than in cities.

Relatedly, the inconsistent penetration of smartphones – which remain much more expensive than simple mobile phones and are often beyond the means of poor households – remains another technological barrier to implementing inclusive and wide-reaching awareness-raising campaigns.

As far as community engagement is concerned, the monetary and time investments required to organize meetings is sometimes too heavy for small companies. Private initiatives led by dense networks of local agents are supplemental to state-led campaigns but are also very difficult to organize. The durability of the initiatives relies on opinion leaders acting as relays within the community to spread messages themselves.

Current market landscape of the solution

Community-level sensitization campaigns tend to be prioritized in emerging markets, where digital media access is still limited in rural areas. In Ghana in 2017, the National Petroleum Authority (NPA) implemented a nationwide LPG safety campaign to educate consumers on the safe use of LPG, in response to a spate of LPG-related accidents including explosions and fire outbreaks in parts of the country. Officials of NPA visited restaurants, hotels, and traditional eateries known as “chop bars” operators in all regions to teach them on the safe use of LPG [179]. This initiative is reminiscent of a local practice called “durbar” (literally “community gathering”) that has been playing a prominent role in enhancing safety through proximity and dialogue in Ghana [40].

In Bangladesh, in late 2018, the government declared that it would launch an awareness campaign, jointly organized by the Energy Division and the LPG Owners’ Association, to prevent gas blasts during the use of LPG [180].

In more developed markets, the use of digital media to target customers is more systematic and gives a foretaste of what future campaigns could look

like in markets experiencing a rapid development of internet technologies, notably in East Africa. In Kuwait, for example, Kuwait Oil Tanker Company started communicating online on LPG safety through awareness campaign videos destined to LPG filling plant professionals as well as customers confronted to leaks.

In Abu Dhabi, ADNOC (Abu Dhabi National Oil Company) launched the “Safety: it’s in Your Hands” campaign in 2016, encouraging customers to get safety tips through the company’s social media accounts (Twitter, YouTube, Facebook, LinkedIn, Instagram) [67].

Summary of adoption potential in developing countries

Figure 18 - Assessment of innovative education media’s potential in developing countries

Market dynamics	Affordability	Safety benefits
High	High	High
Medium	Medium	Medium
Low	Low	Low

5. CONCLUSIONS AND RECOMMENDATIONS

Concerns about the safety of LPG can discourage households from switching to the fuel for cooking, reduce appetite for investment for private firms, and therefore undermine market growth in developing countries.

» For companies, safety represents a commercial and reputational risk that discourages investment.

» For households, fear of accidents reduces their willingness to switch to LPG as a cooking fuel.

The findings of this report are intended to serve as a comprehensive summary of safety issues in LPG for public authorities, investors, and industry professionals, as well as the potential mitigation measures. By having a clearer vision of these challenges and mitigation measures, the private sector will be encouraged to increase investment into the sector.

New technologies are emerging that can make a real contribution to enhancing safety in the LPG sector. These technologies also address other major barriers to LPG use, particularly affordability, accessibility, and supply chain management. Among the different innovations appearing in the LPG sector, two groups of solutions are differentiated, each with different time-to-market horizons: lower-tech solutions that can be implemented at relatively low cost, and more complex and innovative technologies that hold promise in the longer term.

Low-tech solutions

Four technologies represent more immediate and lower cost opportunities to increase safety and promote the uptake of LPG, at a relatively affordable cost for companies and consumers.

» **Home delivery**, which permits professional delivery personnel to correctly install LPG cylinders and teach customers best practices, while offering customers greater convenience and reassurances about safety.

» **Cylinder tracking**, which improves safety during the transport and refilling of cylinders, while improving operational management for companies.

» **Consumer education** through digital media such as social networks and content sharing platforms, which allows businesses and authorities to transmit safety and other marketing messages to customers.

» **Advanced cooking equipment**, such as advanced hoses and improved valves, which can significantly reduce accident rates in homes, often at very low cost.

Their benefits are summarized on the next page.

Table 7 - Summary of low-tech solutions' benefits

	Market maturity	Affordability	Safety impact
Home delivery	High	Medium	High
Cylinder tracking	High	Medium	High
Consumer education through digital media	High	High	High
Advanced cooking equipment	Medium	High (hoses) Medium (valves) Low (burners)	High

With respect to these solutions, the following actions are recommended:

» LPG distributors should look to roll out these low-cost technologies and business practices. Most of these technologies offer "dual-wins" for distributors.

» Home delivery increases consumer satisfaction and customer loyalty, as well as safety.

» Cylinder tracking improves supply-chain management and reduces operational costs, as well as ensuring supply chain safety.

» Digital media not only can be used to transmit safety messages, but also cooking tips, special promotions and other methods to increase customer loyalty.

» Advanced cooking equipment can not only give customer more reassurance on safety, and additional revenue stream for distributors.

» Collectively, these technologies would increase safety in the LPG value chain and give confidence to those distributors and multinational companies who have been unwilling to invest based on safety concerns. In addition, in several countries, such as Kenya, the regulatory environment is now improving, moving to a branded-cylinder

recirculation model, which should further increase safety.

» Investors should study businesses that are developing technologies in these areas. Increased investment is needed to support deployment around the world, particularly to lower income countries. In addition, these technologies all have the chance to be deployed at scale to the hundreds of millions of households already using LPG, representing a unique investment opportunity.

» Governments and development partners can support deployment of technologies, particularly in areas currently underserved by LPG.

» Governments can support pilot home delivery initiatives to rural communities would be a high impact way to increase reach to rural communities, as well as safety.

» Public funding can also be used to carry out digital awareness campaigns to educate clients about clean cooking services, and in particular how to safely use LPG through, for example, social media and mobile-compatible videos. Alternatively, governments and development partners can fund pilots from LPG distributors to develop mobile applications to transmit messages to customers.



LPG canister delivery in Tanzania (Circle Gas)

- » Governments and regulators should consider promoting these solutions by introducing and enforcing at least basic standards, such as making cylinder tracking and certain hose and valve technologies mandatory.
- » Governments also need to ensure a stable and well enforced legal and regulatory environment, to allow for private sector investment.

Advanced technologies

Four emerging, innovative technology-enabled solutions also have the potential in the longer term to make a significant contribution to increasing safety, as well as offering other benefits to distributors and/or consumers:

- » **Composite cylinders**, which are lighter, explosion-proof, corrosion-free, provide higher mechanical resistance, and are sometimes translucent (making gas level visible), can enhance safety as well as make cooking with LPG more convenient and easier for households. They are being increasingly adopted in some advanced economies and are starting to be rolled out in key emerging markets. They undoubtedly represent the future of LPG cylinders, but their relatively high cost is likely to be a barrier to their adoption in poorer developing countries in the near term.
- » **Smart metering systems and Pay-As-You-Cook business models**, which use smart valves that allow end customers to keep track of their exact

gas consumption and pay with mobile money for small volumes of LPG according to their needs (hence the “pay-as-you-cook” expression). In addition to improving affordability by reducing the upfront cost of LPG, these systems also increase safety. The business model is being tested, costs are coming, and regulations and standards are being defined. Though there is significant traction in the market, the business model and technology will need to mature before reaching scale.

- » **Smart gas sensors**, which permit monitoring of the volume of gas in the cylinder, automatically triggering doorstep deliveries and alerting the user and distributor in the event of a gas leak. This technology can greatly improve supply chain management, as well as safety. However, costs make this technology unlikely to reach frontier markets in the short term.
- » **Advanced leak detection systems** installed at distribution facilities and homes, which detect leaks and transmit information to the relevant party through using an ‘internet of things’ modality. This can then potentially trigger emergency procedures. Whilst this solution may make sense at LPG refilling stations facilities, the costs are currently too high for mass scale-up.

In terms of recommendations:

- » **Foundations, governments and universities** can further **fund R&D into these advanced innovations** with the aim to make them more affordable on a larger scale. Grant capital

Table 8 - Summary of advanced technologies’ benefits

	Market maturity	Affordability	Safety impact
Composite cylinders	Medium	Medium	Medium
Smart metering systems / Pay-As-You-Cook business models	Low	Medium	Medium
Smart gas sensors	Low	Low	Medium
Advanced leak detection systems	Low	Medium	High

would likely be most appropriate at this stage, given the early-stage nature of several of these technologies.

- » **LPG distributors should continue to pilot these technologies**, in order to refine business models, find ways to reduce costs, and develop improvements that allow this technology can reach wider market penetration.
- » **Industry majors** can also accelerate their roll-out **by establishing partnerships with start-ups** using these technologies, as well as identifying sustainable business plans for these projects.
- » **Early-stage investors should look to invest in high-return start-ups** developing these technologies. If the cost of these technologies can be reduced, they could play an important role in increasing safety for the hundreds of millions of households that currently use, or will use, LPG in the future—while creating significant commercial opportunities.
- » **Public institutions** can **fund studies assessing how these technologies increase safety**.

In the case of Pay-As-You-Go and smart-meter technology, the market has already sent positive signals with significant investments in companies like PayGo Energy (US\$1.43 million debt and equity seed round in 2017 involving Novastar Ventures, Energy Access Ventures and five other investors [182]) or KopaGas (whose technology was acquired January 2020 by Circle Gas in a transaction worth US\$25 million [149]). Many large multinationals and regulatory bodies interviewed stated they were most excited by this technology which tackles both safety and affordability challenges.

In short, new modern technologies are emerging that simultaneously increase LPG safety, as well as solve other critical pain-points such as affordability, accessibility and supply chain management. These offer an opportunity to increase investment in the LPG sector, and distributors, investors and public bodies should all be actively looking to support adoption, so as to ensure that more people obtain access to modern cooking services—while creating significant commercial opportunities through an expansion of the market.

APPENDIX 1 – SAFETY FIRST: BEST PRACTICES IN LPG

The Clean Cooking Alliance and ENEA Consulting hosted an interactive discussion with expert panelists and audience members at the Alliance’s Clean Cooking Forum 2019.

The session, titled “Safety First: Best Practices in LPG”, was designed to solicit inputs to inform the development of this report, specifically regarding safety-related market barriers, private sector innovation, new private sector opportunities, and other means of overcoming safety barriers that inhibit LPG market growth.

Session Description:

To develop a commercially viable clean cooking industry requires a range of affordable, high-quality, and reliable products and services. LPG has the potential to be one of those products, but has several associated safety implications, both real and perceived, surrounding its supply chain. LPG safety issues are traditionally addressed through policy and regulation, which can be long and complicated processes and become particularly challenging once illegal practices become pervasive. These issues not only inhibit uptake and adoption by consumers, but also impede investment flow, business growth, commercialization, and market entry. However, private sector-led innovations that can mitigate safety issues, either directly or indirectly, have begun to gain traction and drive market growth.

Panel:

- » Richard Scotney, ENEA Consulting (moderator)
- » Dr. Ahsif Ahamed, Hexagon Ragasco
- » Wanjiku Manyara, Petroleum Inst. of East Africa
- » Elizabeth Muchiri, Global LPG Partnership
- » Michael Kelly, World LPG Association
- » Fausto Marcigot, PayGo Energy

Top Takeaways:

- » Perception vs. Reality
 - » Safety, real or perceived, has an impact on LPG adoption.
 - » Next to the issue of sustainability of supply, consumers’ concerns are about the safety of LPG.
 - » Local news stories of LPG cylinder explosions due to improper storage or leaks and proximity to fire, as well as the potential for safety problems through illegal refilling practices, deter consumers from using LPG.
 - » LPG safety is not just about preventing explosions or fires, but it also includes safety of installation and the health of the individual who carry heavy cylinders. Many consumers who use LPG have little knowledge of the tools they need to own in order to safely use LPG

in their homes. LPG cylinders are also often quite heavy when full, and many consumers must walk long distances carrying the cylinders to return home. To mitigate this health challenge, some companies have designed LPG cylinders that not only prevent explosions but are also lighter.

- » So long as best practices are observed, the product is safe for customers to use.
- » The Role of Innovation and Regulation Across the Supply Chain
 - » From the design of the cylinder to the person who’s transporting it, safety is key.
 - » In countries such as Kenya, the Government has taken steps towards ensuring LPG safety by revising its LPG regulatory framework. These regulations make safety the responsibility of LPG business, not just the consumers.
 - » Part of ensuring safety also includes having training, education, and standards and that those standards are enforced through regulations. This means ensuring that all businesses do their innovation work around LPG as prescribed in a standard. New innovative approaches to safety are emerging.
 - » The use of mobile phones and the Internet of Things (IoT) are opening many new opportunities for innovation in safety in the LPG market. Smart meters allow distributors and consumers to monitor the levels of LPG in their cylinders, which enables the distributors to deliver refills safely and in a timely manner. Consumers and distributors can also track the transport of their LPG cylinders to know where they are and when they’ll arrive.



Photo: World LPG Association

REFERENCES

- [1] K. Thoday, P. Benjamin, M. Gan et E. Puzzolo, «The Mega Conversion Program from kerosene to LPG in Indonesia: Lessons learned and recommendations for future clean cooking energy expansion,» 2018.
- [2] S. Rose Eilenberg, K. R. Bilsback, M. Johnson, J. K. Kodros, E. M. Lipsky, A. Naluwagga, K. M. Fedak, M. Benka-Coker, B. Reynolds, J. Peel, M. Clark, M. Shan, S. Sambandam, C. L'Orange, J. R. Pierce, R. Subramanian, J. Volckens et A. Robinson, «Field measurements of solid-fuel cookstove emissions from uncontrolled cooking in China, Honduras, Uganda, and India,» 2018.
- [3] Climate and Development Knowledge Network, «Dalberg Report - Mobilising Investment - Cleaning up cooking in urban Kenya with LPG and bio-ethanol,» 2018.
- [4] A. Rahnema, F. Sánchez et P. Giordano, «Alternative cooking fuels in Kenya: How can household decision making be influenced,» 2017.
- [5] C. M. Lee, C. Chandler, M. Lazarus et F. X. Johnson, «Assessing the Climate impacts of cookstove projects issues in emissions accounting,» Stockholm Environment Institute, 2013.
- [6] M. A. Jeuland et S. K. Pattanayak, «Benefits and Costs of Improved Cookstoves: Assessing the implications of variability in health, forest and climate impacts,» 2012.
- [7] G. Hutton, E. Reguess, F. Tediosi et S. Weiss, «Evaluation of the costs and benefits of household energy and health interventions at global and regional levels,» World Health Organization, 2006.
- [8] WLPGA (The World LPG Association), «Sustainable Development Goals - Contributions of LPG,» 2019.
- [9] International Energy Agency (IEA), «Energy Access Outlook 2017,» IEA, 2017.
- [10] Leeuwen et R. Van, «Scaling up clean cooking with LPG,» The Global LPG Partnership, 2018.
- [11] International Energy Agency (IEA), «Africa Energy Outlook 2019,» IEA, Paris, 2019.
- [12] ENEA & Menecon Consulting, «Analysis based on IEA and UN data,» 2019.
- [13] Clean Cooking Alliance, «Scaling LPG for cooking in developing markets: insights from Tanzania,» 2019.
- [14] H. Farabi-Asl, F. Taghizadeh-Hesary, A. Chapman, S. M. Bina et K. Itaoka, «Energy challenges for clean cooking in Asia, the background and possible policy solutions,» 2019.
- [15] O. B. Ozoh, T. J. Okwor, O. Adetona, A. O. Akinkugbe, C. E. Amadi, C. Esezobor, O. O. Adeyeye, O. Ojo, V. N. Nwude et K. Mortimer, «Cooking Fuels in Lagos, Nigeria: Factors Associated with Household Choice of Kerosene or Liquefied Petroleum Gas (LPG),» 2018.
- [16] C. F. Gould, S. B. Schlesinger, E. Molina, M. Lorena Bejarano, A. Valarezo et D. W. Jack, «Household fuel mixes in peri-urban and rural Ecuador: Explaining the context of LPG, patterns of continued firewood use, and the challenges of induction cooking,» 2019.
- [17] J. Hollada, K. N. Williams, C. H. Miele, D. Danz, S. A. Harvey et W. Checkley, «Perceptions of Improved Biomass and Liquefied Petroleum Gas Stoves in Puno, Peru: Implications for Promoting Sustained and Exclusive Adoption of Clean Cooking Technologies,» 2017.
- [18] Energia, WLPGA (The World LPG Association), «Cooking with Gas: 2018 update why women in developing countries want LPG and how they can get it,» 2019.
- [19] World Bank Group, «Lessons Learned from Nigeria The Case of Cameroon and Ghana,» World Bank, Washington, DC., 2012.
- [20] F. Adekoya, «FG urges review of building codes to increase LPG penetration,» The Guardian, 22 January 2020.
- [21] S. Jaworski, «Propane Tank Fires & Explosions - Expert Article,» 2018. [En ligne]. Available: <https://www.robsonforensic.com/articles/propane-tank-fires-explosions-expert>.
- [22] T. Burden, «Safe Propane Installations,» 2019. [En ligne]. Available: www.westmarine.com/WestAdvisor/Safe-Propane-Installations.
- [23] Pacific Coast Energy, «Propane Safety Portable Tank FAQ,» [En ligne]. Available: https://www.google.com/url?sa=i&rct=j&q=&esrc=s&source=images&cd=&ved=2ahUKewjPi96bwa_mAhVszzzGHVVF2A9EQjhx6BAGBEAl&url=https%3A%2F%2Fpacificcoast-energy.net%2Fpropane-safety-portable-tank-faq%2F&psig=AOvVaw1073PyxnSW3ZY_DRsnT9V6&ust=1576219463222718.
- [24] R. B. Ahuja, J. K. Dash et P. Shrivastava, «A comparative analysis of liquefied petroleum gas (LPG) and kerosene related burns,» 2011.
- [25] Campingstoves.com, «Koblenz PFK-200 Lucero 2-Burner Gas Stove, Maroon,» [En ligne]. Available: https://gasoline.campingstoves.biz/koblenz-pfk-200-lucero-2-burner.html?product_id=JvKs9y3pEimBQQ.
- [26] Amazon, «PoundSaver Cast Iron Large Gas LPG Burner Cooker Gas Boiling Ring Portable Restaurant Catering,» [En ligne]. Available: <https://www.amazon.co.uk/PoundSaver%C2%AE-Boiling-Portable-Restaurant-Catering/dp/B0763SFJ9B>.
- [27] Clean Cooking Alliance, «LPG Stove Télia n°2,» [En ligne]. Available: <http://catalog.cleancookstoves.org/stoves/316>.
- [28] M. Dalaba, R. Alirigia, E. Mesenbring, E. Coffrey, Z. Brown, M. Hannigan, C. Wiedinmyer, A. Oduro et K. L. Dickinson, «Liquefied Petroleum Gas (LPG) Supply and Demand for Cooking in Northern Ghana,» EcoHealth, 2018.
- [29] WLPGA (The World LPG Association), «Guidelines for Good Safety Practices in the LPG Industry,» 2015.
- [30] International Organization for Standardization, «ISO 10691:2004 Gas cylinders – Refillable welded steel cylinders for liquefied petroleum gas (LPG) – Procedures for checking before, during and after filling,» August 2004. [En ligne]. Available: <https://www.iso.org/standard/34235.html>.
- [31] Petroleum and Natural Gas Regulatory Board, «Petroleum and Natural Gas Regulatory Act,» New Delhi, 2006.
- [32] A. G. Farran – UNAMID, «El Fasher: Central Gas Station in El Fasher. Every morning, dozens of shop keepers come to the station to collect LPG (Liquefied petroleum gas) bottles for distribution to the city. », 2012. Available: <https://www.flickr.com/photos/unamid-photo/6823281102>.
- [33] University of St Andrews, «Gas Cylinders - Safe Use of Gas Cylinders (GUIDANCE),» [En ligne]. Available: <https://www.st-andrews.ac.uk/staff/policy/healthandsafety/publications/gascylinders-safeuseofgascylindersguidanc/>.
- [34] Calor Gas Ltd., «The Carriage of Dangerous Goods and Use of Transportable Pressure Equipment Regulations 2007 (CDG&UT-PER),» Calor Gas Ltd., 2007.
- [35] The Trade Association for the LPG industry in the UK (UKLPG), «User information sheet 028: Safe use of propane and butane cylinders and cartridges,» 2014.
- [36] British Compressed Gases Association (BCGA), «The safe use of individual portable or mobile cylinder gas supply equipment,» BCGA, 2018.
- [37] M. Pomela, «Home gas distribution in Brazil,» [En ligne]. Available: <https://thebrazilbusiness.com/article/home-gas-distribution-in-brazil>.
- [38] A. Jain, S. Tripathi, S. Mani, S. Patnaik, T. Shahidi et K. Ganesan, «Access to Clean Cooking Energy and Electricity: Survey of States 2018,» Council on Energy, Environment and Water, New Delhi, 2018.
- [39] WLPGA (The World LPG Association), «Guide to Good Industry Practices for LPG Cylinders in the Distribution Channel 2019,» World Liquefied Petroleum Gas Association, 2019.
- [40] K. P. Asante, S. Afari-Asiedu, M. A. Abdulai, M. A. Dalaba, D. Carrion, K. Dickinson, A. N. Abeka, K. Sarpong et D. Jack, «Ghana's rural liquefied petroleum gas program scale up: A case study,» 2018.
- [41] D. Bareja, «Hazardous Goods Transport», Pendjab, India, 2012. Available: <https://www.flickr.com/photos/dineshobareja/6815673421>.

- [42] Bankbazaar.com, «LPG Gas Connection – Precautions & Safety Tips,» 2016. [En ligne]. Available: <https://www.bankbazaar.com/gas-connection/lpg-gas-connection-precautions-and-safety-tips.html>.
- [43] N. Sharma, «LPG-related accident raises questions over government initiative to provide clean cooking gas to poor,» The Economic Times, 2016.
- [44] Eneris & Public Health Institute, «Scaling up demand for LPG in Guatemala Final report,» 2015.
- [45] Khusoko, «Government Approves New Regulations to Fight Illegal LPG Cylinders,» Khusoko, 11 6 2019.
- [46] WLPGA (The World LPG Association), «Managing the Life Extension of LPG Cylinders,» 2016.
- [47] WLPGA (The World LPG Association), «Report on the Testing and Requalification of LPG Cylinders,» 2015.
- [48] W. G. Matthews et H. R. Zeissig, «Residential Market for LPG A Review of Expreience of 20 Developing Countries,» 2011.
- [49] Engineering for change, «Kenya Introduces the World’s First LPG Smart Metering Standard,» 8 October 2019. [En ligne]. Available: <https://www.engineeringforchange.org/news/kenyan-bureau-standards-launched-worlds-first-lpg-smart-metering-standard/>. [Accès le 2019].
- [50] Energy and Petroleum Regulatory Authority (EPRA) , «About Us: Our Mandate,» [En ligne]. Available: <https://www.epra.go.ke/about/>. [Accès le 08 12 2019].
- [51] Liquefied Petroleum Gas Safety Association of South Africa, «Briefing to Parliament on LP Gas Safety,» 2018.
- [52] J. H. Lehr et J. Keeley, «Alternative Energy and Shale Gas Encyclopedia,» 2016.
- [53] GhanaWeb, «President Akufo-Addo activates cylinder circulation program,» GhanaWeb, 13 10 2017.
- [54] A. Chepkoech, «Govt approves new laws in fight against illegal gas trade,» Daily Nation, 2019.
- [55] A. Ambituuni, J. Amezaga et E. Emeseh, «Analysis of safety and environmental regulations for downstream petroleum industry operations in Nigeria: Problems and prospects,» 2014.
- [56] WLPGA (The World LPG Association), «Accelerating the LPG Transition,» 2018.
- [57] I. M. Ralby, «Downstream oil theft: global modalities, trends, and remedies,» 2017.
- [58] Asean Affairs, «Thailand: LPG smuggling continues despite ban,» Asean Affairs, 16 06 2008.
- [59] T. Hossain, «Distribution process, challenges and ways to overcome such challenges for domestic category of Laugfs Gas Bangladesh Ltd,» 2018.
- [60] L. Toft, C. Beaton et L. Lontoh, «International Experience With LPG Subsidy Reform: Options for Indonesia,» 2016.
- [61] S. Ronzi, E. Puzzolo, L. Hyseni, J. Higgerson, D. Stanistreet, M. Hugo, N. Bruce et D. Pope, «Using photovoice methods as a community-based participatory research tool to advance uptake of clean cooking and improve health: The LPG adoption in Cameroon evaluation studies.,» 2019.
- [62] Worksafe, «LPG in industry - quick guide,» 21 August 2018. [En ligne]. Available: <https://worksafe.govt.nz/topic-and-industry/hazardous-substances/guidance/substances/liquified-petroleum-gas-lpg/lpg-in-industry/#f-doc-47382>.
- [63] Indian Oil, «LPG installation Safety Tips,» [En ligne]. Available: http://mylpg.in/docs/Consumer_Guidance.pdf.
- [64] Ghanaian Chronicle, «Fuel wood consuming Ghana’s forest,» Modern Ghana, 11 05 2011.
- [65] L. Ahunu, «LPG Promotion Program,» Africa Center for Energy Policy, 2015.
- [66] Africa Parliamentary Monitoring Group, «Energy Safety Issues: briefings by Eskom, Paraffin Safety Association of Southern Africa, Liquefied Petroleum Gas Safety Association of South Africa & National Union of Metalworkers of South Africa,» 2012.
- [67] Abu Dhabi National Oil Company (ADNOC), «ADNOC Distribution to Launch Public Awareness Campaign to Promote Safe Use of LPG Cylinders and Regulators,» 07 08 2016. [En ligne]. Available: <https://www.adnocdistribution.ae/en/media/press-releases/2016/lpg-awareness-campaign/>.
- [68] Indian Oil Corporation Limited, Réalisateur, Tips for safe usage of LPG. [Film]. 2017.
- [69] A. R. Ray, «Bengaluru saw most LPG accidents in 2013,» Times of India, 15 04 2015.
- [70] Natpet Investments Company Limited (Natpet), «Safety Tips,» [En ligne]. Available: <https://www.np.co.tt/our-brands/np-gas/>. [Accès le 08 12 2019].
- [71] M. Kojima, «The Role of Liquefied Petroleum Gas in Reducing Energy Poverty,» 2011.
- [72] T. Ashok et A. Harikrishna, «Analysis Of Lpg Cylinder Using Composite Materials,» 2013.
- [73] Department for Communities & Local Government, «Fire and Rescue Service Operational guidance incidents involving hazardous materials,» 2012.
- [74] A. Tripathi, A. Kumar et M. Chandrakar, «Design and Analysis of a Composite Cylinder for the Storage of Liquefied Gases,» 2017.
- [75] Time Technoplast Limited, «The new generation of 100% explosion proof LPG composite cylinders: LifeSafe,» 2017.
- [76] M. B. Mocketla et M. Shukla, «Design and finite element analysis of FRP LPG cylinder,» Johannesburg, South Africa, 2012.
- [77] Rubigas , «Rubigas Composite Bottle,» [En ligne]. Available: <https://www.rubis-caribbean.com/product/rubigas-composite-bottle/>.
- [78] Hexagon Ragasco, «Shop: Viking Cylinders by Hexagon Ragasco,» [En ligne]. Available: <https://www.vikingcylinders.com/shop/>. [Accès le 08 12 2019].
- [79] Nassau County Fire Service Academy, «Special Interest Bulletin – Sept. 05 Composite LPG Cylinders,» 2006.
- [80] WLPGA (The World LPG Association), «Guide to Good Industry Practices for LP Gas Cylinder Management,» 2013.
- [81] Rubis, «Rubis Composite Bottle,» [En ligne]. Available: <https://www.rubis-caribbean.com/product/rubigas-composite-bottle/>. [Accès le 08 12 2019].
- [82] R. S. Dr. Irani, «From Napoleon to Norway – The development of composite cylinders,» gasworld.com.
- [83] Acquire Market Research, «Global Composite LPG Cylinders Market Research (2015-2019) and Future Forecast (2020-2025),» 27 November 2019. [En ligne]. Available: <https://www.acquiremarketresearch.com/industry-reports/composite-lpg-cylinders-market/244654/>.
- [84] GlobeNewswire, «Viking Cylinders, a Hexagon Ragasco, brand joins the Arbor Day Foundation’s Time for Trees™ Initiative,» 6 December 2019.
- [85] The Himalayan Times, «Composite LPG cylinders fail to find market as cost is high,» The Himalayan Times, 31 01 2018.
- [86] Hexagon Ragasco, «Annual Report 2018,» 2018.
- [87] Wikipedia, «Pertamina,» [En ligne]. Available: <https://en.wikipedia.org/wiki/Pertamina>. [Accès le 2020].
- [88] WLPGA (The World LPG Association), «WLPGA - Mediaroom - Pertamina Tests the Market for Bright Gas 3 kg,» 3 August 2018. [En ligne]. Available: wlpga.org/mediaroom/pertamina-tests-the-market-for-bright-gas-3-kg/.
- [89] A. Sukapto, Bright Gas, the safest technology, The Wallflower & the Wildflower Blog, 2017.
- [90] J. A. Witz et D. C. Cox, «U.S. Patent No. 9,441,766.,» U.S. Patent and Trademark Office, Washington, DC, 2016.
- [91] KMHouseIndia, «Suraksha Hose Mandatory for Domestic Use of LPG Cylinders,» 10 September 2015. [En ligne]. Available: <http://kmhouseindia.blogspot.com/2015/09/suraksha-hose-mandatory-for-domestic.html>.

- [92] Sabrina & Brad, «Gas Delivery», 2006. Available: <https://www.flickr.com/photos/madaboutshanghai/111186659>.
- [93] G. Shen, M. D. Hays, K. R. Smith, C. Williams, J. W. Faircloth et J. J. Jetter, «Evaluating the Performance of Household Liquefied Petroleum Gas Cookstoves,» *Environmental Science & Technology*, 2017.
- [94] P. Gerber, International Catholic Migration Commission, 2015. Available: <https://www.flickr.com/photos/icmc-migration/23303584795>.
- [95] Air Products and Chemicals Inc., «Safetygram 23 - Cylinder valves,» 2016.
- [96] Hunker, «Home hacks & answers - Home appliances - Other home appliances - What Is an Infrared Gas Stove?,» 2018. [En ligne]. Available: <https://www.hunker.com/13408295/what-is-an-infrared-gas-stove>.
- [97] IndiaMART, «Suraksha LPG Hose,» [En ligne]. Available: <https://www.indiamart.com/proddetail/suraksha-lpg-hose-7080775073.html>. [Accès le 2020].
- [98] Expat Indo, «Pertamina Bright Gas,» 26 May 2017. [En ligne]. Available: <https://www.expatingdo.org/community/threads/pertamina-bright-gas.2324/>.
- [99] OShopping, «Super Genic Infrared Gas Stove with Free Knife Set,» [En ligne]. Available: <https://oshopping.com.ph/super-genic-infrared-gas-stove-free-knife-set.html>. [Accès le 27 January 2020].
- [100] Trovan, «TROVAN EX Cylinder Tracking System: make better, faster decisions,» 2018. [En ligne]. Available: <https://www.trovan.com/en/lpg-supply-chain/trovan-lpg>.
- [101] Alizent, «CEPSA Deploys Athelia's Gasflow For their cylinder tracking and production,» 2016. [En ligne]. Available: https://www.alizent.com/wp-content/uploads/dlm_uploads/2016/10/success-story-gasflow-cepsa-1-1en.pdf.
- [102] Trakaid, «Lpgotrak: LPG Cylinder plant & distribution & consumer delivery\pickup tracking solution,» 2019. [En ligne]. Available: <https://www.trakaid.com/lpgotrak/>.
- [103] A. Nakabi, Z. Beidouri et B. Othmane, «RFID to enhance visibility in a closed loop supply chain: case of cylinders management in a Moroccan LPG distribution chain,» *International Journal of Computer Science Issues*, 2012.
- [104] T. Lotlikar, R. Kankapurkar, A. Parekar et A. Mohite, «Comparative study of Barcode, QR-code and RFID System,» *Int. J. Comput. Technol. Appl.*, 2013.
- [105] N. C. Karmakar, M. Zomorodi et C. Divarathne, «Advanced chipless RFID: MIMO-based imaging at 60 GHz-ML detection,» *John Wiley & Sons.*, 2016.
- [106] C. W. Mutua, «A mobile application for tracing and verification of the authenticity of filled liquefied petroleum gas cylinders,» *Strathmore University*, 2017.
- [107] Trakaid, «Why Should You Never Opt for Bar Codes to Track Gas Cylinders Again,» 7 April 2015. [En ligne]. Available: <https://www.trakaid.com/never-opt-bar-codes-track-gas-cylinders/>.
- [108] TrackAbout, «Asset Tracking Industry Selection Guide,» 2019.
- [109] Ashish, «What's a QR Code And How Is It Different From A Barcode?,» 2016. [En ligne]. Available: <https://www.scienceabc.com/innovation/whats-qr-code-how-its-different-from-barcode.html>.
- [110] Alibaba, «QR barcode for LPG cylinder tracking and management system,» [En ligne]. Available: https://www.alibaba.com/product-detail/QR-barcode-for-lpg-cylinder-tracking_60729714927.html.
- [111] Chainway, «Gas Cylinder Tracking Using Barcoding Technology,» [En ligne]. Available: <https://www.chainway.net/Cases/Info/75>.
- [112] BarScan Technologies, «Specialty Industrial Labels: Gas cylinder labels,» 7 January 2020. [En ligne]. Available: <http://www.bar-scantechologies.com/GasCylinderLabels.html>.
- [113] ChuanDa KeHong New Technology Institute, «Civil Gas Cylinder (LPG) Dynamic Quality and Safety Regulation System,» *ChuanDa KeHong New Technology Institute, Chengdu*, 2019.
- [114] T. Fusco, «Trends today in asset management,» 2019. [En ligne]. Available: https://corp.trackabout.com/blog/trends-today-in-asset-management?utm_campaign=asset%20guide%20nurture&utm_source=hs_automation&utm_medium=email&utm_content=71380261&_hsenc=p2ANqtz-_BIMgp2EL-UZ-BfxtLkFtyVaHE-1r3Vke_y9giXXPMIIEAMKIK6taJBKWImNw0VLBuob1LrIk5.
- [115] J. J. Lou, G. Andrechak, M. Riben et W. H. Yong, «A review of radio frequency identification technology for the anatomic pathology or biorepository laboratory: Much promise, some progress, and more work needed,» *Journal of pathology informatics*, 2011.
- [116] B. Masin, «Interview With Barbara Masin Of Trovan Ltd, RFID As An Essential Asset Tracking Technology For LPG,» 2018. [En ligne]. Available: <http://www.lpgsummit.com/newsletter5/#trovaninterview>.
- [117] WLPGA (The World LPG Association), «The Internet of Things (IoT): Opportunities for the LPG industry,» *WLPGA (The World LPG Association)*, 2019.
- [118] Cabinet Secretary for Petroleum and Mining, *Legal Notice No. 100 - The Petroleum Act*, 2019.
- [119] H.-H. P. Wu, C.-W. Hung, S.-H. Chang et Z.-H. Yang, «Analysis and Implementation of Noncontact Level Sensing for a Pressurized Cylinder,» *Journal of Sensors*, 2016.
- [120] Sensile Technology, «Telemetry solution for gas cylinders,» 2014. [En ligne]. Available: <https://www.sensile.com/solutions/gas-cylinders/>.
- [121] Truma, «Truma LevelControl Operating Instructions,» 2018.
- [122] YonkeGas, «YonkeGas GasLevel Sensor Assist,» [En ligne]. Available: <https://www.yonkegas.com/index.php/help>.
- [123] Senso4s, «How it works: Senso4s,» [En ligne]. Available: <https://www.senso4s.com/>.
- [124] NUPE, «LPG Smart scale,» *NUPE*, 2019.
- [125] Truma, «Truma LevelControl,» [En ligne]. Available: <https://www.truma.com/int/en/products/truma-caravan-rv-gas-fittings/truma-levelcontrol.html>.
- [126] ENEA Consulting, «Based on interview with Cédric Morel, Managing Director at Sensile Technologies,» 2020.
- [127] Smart Cylinders, «Smart Cylinders Sales brochure (web) 2019,» 2019. [En ligne]. Available: assets.website-files.com/5b4dcebecde7f84ea7013408/5d945c2e1a306d8ede451dd4_Smart-Cylinders-brochure-web-2019.pdf.
- [128] Calor, «Calor - Gas Bottles - Local gas bottle delivery,» [En ligne]. Available: <https://www.calor.co.uk/gas-bottles/advice/delivery>.
- [129] Vite Kenya, «Smarter and simpler way of getting your LPG gas home delivery: Vite-LPG app,» 12 September 2018. [En ligne]. Available: <https://www.vitekenya.com/smarter-and-simpler-way-of-getting-your-lpg-gas-vite-lpg-app/>.
- [130] L. Priyadarsini, «https://twitter.com/fon24pgs_iocl,» 1 November 2019. [En ligne]. Available: https://twitter.com/FON24PGS_IOCL/status/1190261693957296128.
- [131] Elgas, «LPG Gas Safety Guidelines,» [En ligne]. Available: <https://www.elgas.com.au/welcome-to-elgas/lpg-a-safety>.
- [132] H. Dugh, «Want to book LPG cylinder? Beware! Don't lose your money, never do this; read warning,» *ZeeBusiness*, 2019.
- [133] Pugalia Associates, «Indane - Delivery Boy Uniform,» 2018.
- [134] Clean Cooking Association of Kenya (CCAK), «Kenya Household Cooking Sector Study: Assessment of the Supply and Demand of Cooking Solutions,» 2019.
- [135] M. Dalaba, R. Alirigia, E. Mesenbring, E. Coffey, Z. Brown, M. Hannigan, C. Wiedinmyer, A. Oduro et K. L. Dickinson, «Liquified Petroleum Gas (LPG) Supply and Demand for Cooking in Northern Ghana,» 2018.
- [136] Government of India - Ministry of Petroleum and Natural Gas, *Unified Guidelines for Selection of LPG distributorships*, 2016.
- [137] Government of India - Ministry of Petroleum and Natural Gas, *Rajiv Gandhi Gramin LPG Vitaran Yojana*, 2015.

- [138] S. Choudhary, «Home delivery of LPG cylinders to start for most rural consumers soon,» The Economic Times, 16 June 2016.
- [139] S. Choudhary, «Rural LPG delivery to get IT legup,» The Economic Times, 28 August 2018.
- [140] J. Anyanzwa, «Kenya shelves plan for cheap gas to rural homes over safety concerns,» The EastAfrican, 19 May 2018.
- [141] D. Omondi, «Greedy officials killed Sh3b gas project for poor Kenyans,» Standard Digital, 8 September 2019.
- [142] J. Probyn, «'Pay-as-you-cook' energy solution hopes to appeal to rural Africa,» How We Made It In Africa, 28 November 2017.
- [143] Clean Cooking Alliance, «'Pay-as-you-go' technology to boost access to cooking fuel,» 30 May 2017. [En ligne]. Available: <https://www.cleancookingalliance.org/about/news/05-30-2017--pay-as-you-go-technology-to-boost-access-to-cooking-fuel.html>.
- [144] Global System for Mobile Communications, «Mobile-enabled Pay-as-you-Cook service in Tanzania,» Global System for Mobile Communications (GSMA), London, 2019.
- [145] The James Dyson Award, «Nugas LPG smart meter,» 2019. [En ligne]. Available: <https://www.jamesdysonaward.org/2019/project/nugas-lpg-smart-meter/>.
- [146] Envirofit, «Looking Towards the Guatemala LPG Market,» 1 April 2019. [En ligne]. Available: https://envirofit.org/looking-towards_the_guatemala_lpg_market/.
- [147] ENGIE, «Clean Cooking in the Developing World, ENGIE's Recipe for a Sustainable Future,» 7 November 2019. [En ligne]. Available: <https://innovation.engie.com/en/news/news/energy-communities/fenix-fumba-cookstove-making-cooking-in-afica-clean-and-affordable/12983>.
- [148] Circle Gas Limited, «Press Release - KopaGas Acquisition,» 13 January 2020. [En ligne]. Available: <https://circlegas.co.uk/kopa-gas-acquisition/>.
- [149] R. Sarin, «Circle Gas has acquired clean cooking PAYG technology and are launching it in Kenya,» GSMA - Mobile for Development Utilities, 29 January 2020. [En ligne]. Available: <https://www.gsma.com/mobilefordevelopment/programme/m4utilities/circle-gas-has-acquired-clean-cooking-payg-technology-and-are-launching-it-in-kenya/>.
- [150] M. Rowling, «Smart gas cooking seeks to break African cities' dirty charcoal habit,» Reuters, 2019.
- [151] S. Patnaik, S. Tripathi et A. Jain, «Roadmap for Access to Clean Cooking Energy in India,» Council on Energy, Environment and Water (CEEW), 2019.
- [152] The Global LPG Partnership, «GLPGP March 2019 Newsletter,» 2019. [En ligne]. Available: glpgp.org/march-2019-newsletter.
- [153] Envirofit, «How the Clean Cooking Industry Can Overcome its Struggles to Scale,» 16 August 2019. [En ligne]. Available: <https://envirofit.org/smartgas-featured-in-next-billion/>.
- [154] N. Adams, «Bringing poverty-alleviating solutions to market in India, Kenya, Nigeria, Tanzania, and Uganda,» MIT News, 16 August 2017.
- [155] FinDev Gateway, «Innovative Consumer Financing for Cooking Energy Access,» 28 February 2018. [En ligne]. Available: https://www.findevgateway.org/sites/default/files/findev_gateway-glpgp_webinar.pdf.
- [156] J. Alderman, «The Next Big Thing for Pay-as-You-Go,» Stanford Social Innovation Review, 2019.
- [157] BBOX , «BBOX unveils BBOX Cook,» 19 July 2019. [En ligne]. Available: <https://www.bbox.co.uk/bbox-unveils-bbox-cook/>.
- [158] M. Pranay, S. Nancy, M. Stuti, G. Renuka et K. Shivani, «IoT Based LPG Gas Leakage Detector,» International Journal of Scientific Research in Computer Science, Engineering and Information Technology, 2019.
- [159] A. I. Adekitan, V. Matthews O. et O. Olasunkanmi, «A microcontroller based gas leakage detection and evacuation system,» IOP Conference Series: Materials Science and Engineering, 2018.
- [160] U. Shruthi, R. Mohammed, B. Joshua, V. Shelvin et H. C. V., «LPG Monitoring and Leakage Detection System,» chez Institute of Electrical and Electronics Engineers (IEEE) WiSPNET 2017 Conference, 2017.
- [161] Cosmos, «Gas detection & alarm systems product guide for industrial use,» Cosmos, 2016.
- [162] Direct Industry, [En ligne]. Available: <https://www.directindustry.com/prod/seitron-spa/product-63653-1571243.html>. [Accès le 2020].
- [163] Airlight, «Airlight - LPG Leak Alarm,» [En ligne]. Available: <http://airlight.in/lpg-leak-alarm/>.
- [164] T. Agarwal, «Home and Industrial Safety Using Fire and Gas Detection System Using GSM,» 2017. [En ligne]. Available: <https://www.edgefx.in/home-industrial-safety-using-fire-gas-detection-system-using-gsm/>.
- [165] AliExpress, [En ligne]. Available: <https://www.aliexpress.com/item/4000202785887.html>.
- [166] Ambtronics, «Gas Detection System For Commercial Kitchens,» 2019. [En ligne]. Available: <https://ambtronics.com/home/applications/lpg-gas-detection-in-commercial-kitchens/>.
- [167] Daniels Training Services, «Safety Alert From the PHMSA: Risks Associated with LPG Odor Fade,» 19 August 2013. [En ligne]. Available: <https://danielstraining.com/safety-alert-from-the-phmsa-risks-associated-with-lpg-odor-fade/>.
- [168] Elgas, «LPG Gas Blog - Odourant is Added to LPG for Safety,» 2019. [En ligne]. Available: <https://www.elgas.com.au/blog/1980-can-lpg-gas-kill-you-or-make-you-sick-is-lpg-toxic-or-poisonous-flammable>.
- [169] Elgas, «LPG Gas Blog - How to Detect a Gas Leak in Your Home,» Elgas, 2019.
- [170] E. Puisis, «The 8 Best Gas Leak Detectors of 2020 - Make sure your family and house is protected,» 24 September 2019. [En ligne]. Available: <https://www.thespruce.com/best-gas-leak-detectors-4154555>.
- [171] Amazon, «DéTECTEUR de Gaz - Capteur de Fuite de gaz LPG/Gaz Naturel/Charbon, Moniteur de gaz Butane Méthane Propane, Avertissement de Lumière Stroboscopique, Alarme de gaz enfichable Convient pour la Cuisine,» [En ligne]. Available: https://www.amazon.fr/dp/B07YMWS9HF/ref=sspa_dk_detail_1?psc=1&pd_rd_i=B07YMWS9HF&pd_rd_w=XrZ46&pf_rd_p=42b0c882-2f60-488f-b868-d46b19aecf92&pd_rd_wg=4uLbS&pf_rd_r=2MG9HXVP8VGRKCVK5M6&pd_rd_r=6d30fe99-19c0-4581-9252-66af32c3fd6e&spLa=ZW5jcnlwdGVkUXVhbGlm. [Accès le 31 January 2020].
- [172] International Gas Detectors, «Domestic gas detection,» 2019. [En ligne]. Available: <https://www.internationalgasdetectors.com/applications/domestic-gas-detection-systems/>.
- [173] S. Edmunds, «Landlords forced to pay up over missing smoke alarms,» Stuff, 2019.
- [174] N. Gutierrez, «Gas detectors made mandatory in BGC,» Rappler, 13 June 2013.
- [175] Indian Oil Corporation Limited, «Tips for safe usage of LPG,» 2017.
- [176] M. Carr et M. Hartl, «Lightening the load: Labour-saving technologies and practices for rural women,» International Fund for Agricultural Development, 2010.
- [177] L. Priyadarsini, 2019.
- [178] E. Broni-Bediako et R. Amorin, «The Ghana Liquefied Petroleum Gas Promotion Programme: Opportunities, Challenges and the Way Forward,» Innov Ener Res, 2018.
- [179] National Petroleum Authority, NPA Begins Nationwide LPG Safety Campaign, 2017.
- [180] The Independent, «Govt to launch awareness campaign on LPG use,» The Independent, 12 December 2018.
- [181] Kuwait Oil Tanker Company, «Awareness Campaign Videos,» 2019.
- [182] T. Jackson, «Kenya's PayGo Energy raises \$1.43m funding round,» Disrupt Africa, vol. 24, p. April, 2017.
- [183] R. Samervel, «Mumbai: LPG company told to pay Rs 10 lakh for faulty pin, killer blast,» The Times of India, 16 August 2019.
- [184] Clean Cooking Alliance, «Delivering on the SDGs Through Clean Cooking,» [En ligne]. Available: cleancookingalliance.org/feature/delivering-on-the-sustainable-development-goals-through-clean-cooking.html. [Accès le 6 December 2019].

- [185] K. K. Yumkella, «Death by dirty cooking,» Eco-Business, 2019.
- [186] P. Roz, «“Clean” Cooking Energy in Uganda – technologies, impacts, and key barriers and enablers to market acceleration,» Institute of Development Studies, Brighton, UK, 2017.
- [187] Y. A. D. F. B. M. L. C. M. K. Kulsum Ahmed, «Environmental Health and Traditional Fuel use in Guatemala,» Word Bank Energy Sector Management Assistance Program, 2005.
- [188] P. Lloyd, «The safety of paraffin & LPG appliances for domestic use,» 2002.
- [189] Ministry of Energy and Mineral Resources Republic of Indonesia, Ministry of Finance Republic of Indonesia, «Indonesia’s Effort to Phase Out and Rationaliselts Fossil-Fuel Subsidies,» 2019.
- [190] M. A. Tarim, « Evaluation of Burn Injuries Related to Liquefied Petroleum Gas,» Journal of Burn Care & Research, 2014.
- [191] Elgas New Zealand, «LPG Gas Blog - How LPG is Transported,» [En ligne]. Available: <https://www.elgas.co.nz/resources/elgas-blog/250-how-lpg-propane-is-transported-ships-trucks-rail-pipelines>.
- [192] Mexico News Daily, «San Juan Ixhuatepec remembers one of world’s worst industrial disasters,» Mexico News Daily, 2019.
- [193] Windsor Stair, «Overfilled propane tanks pose huge safety risk,» Windsor Stair, 2014.
- [194] Zimbabwe Energy Regulatory Authority, «Petroleum Fire Accidents 2014,» [En ligne]. Available: <https://www.zera.co.zw/index.php/78-home/125-pfa>.
- [195] A. Pandey, «One dead, 4 injured in gas cylinder blast in Hyderabad,» India Today, 2019.
- [196] M. K. Zakaria, «Hundreds of LPG cylinders spill onto road in PD accident,» Straits Times, 2019.
- [197] The News Minute, «Deafening explosion as trucks loaded with 900 LPG cylinders catch fire in Karnataka,» The News Minute, 2016.
- [198] African Eye Report, «Gas Fires: NPA Intensifies Public Education On LPG Usage,» African Eye Report, 10 11 2014.
- [199] K. R. Smith et A. D. Sagar, «LPG subsidy: Analysing the ‘Give it Up’ scheme,» The Economic Times, 2016.
- [200] N. Mittal, A. Mukherjee et A. Gelb, «Fuel Subsidy Reform in Developing Countries: Direct Benefit Transfer of LPG Cooking Gas Subsidy in India,» Center for Global Development, 2017.
- [201] Arab News, «Response to fiberglass LPG cylinders lukewarm,» Arab News, 09 07 2010.
- [202] S. Masood, «Pakistan Train Catches Fire, Killing More Than 70,» The New York Times, 31 10 2019.
- [203] UN Environment Programme, «Empowering Sudan’s women and promoting peace through equitable use of natural resources,» 2019.
- [204] World Health Organization (WHO), «Burning Opportunity: Clean Household Energy for Health, Sustainable Development, and Wellbeing of Women and Children,» 2016.
- [205] S. Gupta et G. Farooqui, «Analysis of Direct Benefit Transfer for LPG (Pahal) in India-issues and Challenges,» 2017.
- [206] World Health Organization (WHO), «Household air pollution and health,» 8 May 2018. [En ligne]. Available: <https://www.who.int/news-room/fact-sheets/detail/household-air-pollution-and-health>.
- [207] World Health Organization (WHO), «Opportunities for transition to clean household energy: application of the Household Energy Assessment Rapid Tool (HEART) in India,» 2018.
- [208] WLPGA (The World LPG Association), «Substituting LP Gas for Wood: Carbon and Deforestation Impacts,» 2015.
- [209] WLPGA (The World LPG Association), «The Socioeconomic impact of switching to LPG for cooking,» 2018.
- [210] Z. A. Chafe, M. Brauer, Z. Klimont, R. V. D. S. Mehta, S. Rao, K. Riahi et F. Dentener, «Household Cooking with Solid Fuels Contributes to Ambient PM2.5 Air Pollution and the Burden of Disease,» 2014.
- [211] The World Bank, WLPGA (The World LPG Association), «The Role of LP Gas in Meeting the Goals of Sustainable Development,» 2001.
- [212] M. Bhatia et N. Angelou, «Beyond Connections: Energy Access Redefined,» 2015.
- [213] D. Rutu, K. Sandra, K. B. Bonsuk, F. Gina, P. Elisa et R. Dana, «Cambodia – Beyond Connections : Energy Access Diagnostic Report Based on the Multi-Tier Framework,» World Bank, Washington, DC, 2018.
- [214] International Energy Agency (IEA), «SDG7: Data and Projections,» IEA, Paris, 2019.
- [215] B. NG, K. Aunan et R. EA, «Liquified Petroleum Gas as a Clean Cooking Fuel for Developing Countries: Implications for Climate, Forests and Affordability,» 2017.
- [216] C. Suerte Felipe, «Records of the Bureau of Fire Protection: 50% of LPG tanks in Phl are defective,» The Philippine Star, 2011.
- [217] Y. M. Ahmed, H. D. Lafta, A. A. A. Rahman et B. T. Salih, «Study the Durability of Welding and Performance of Base Metal of LPG Home Cylinder Manufactured in Kurdistan Region,» International Journal of Engineering Materials and Manufacture, 2019.
- [218] M. H. Wood, «Lessons learned from LPG/ LNG accidents,» European Commission, 2016.
- [219] N. Bariha, I. M. Mishra et V. C. Srivastava, «Analysis of fire and explosion hazards during surface transport of liquefied petroleum gas: A case study,» 2014.
- [220] Malaysia Department of Occupational Safety & Health (DOSH), «Fire and Explosion in a LPG Storage Facility,» 27 November 2019. [En ligne]. Available: http://www.dosh.gov.my/doshv2/index.php?option=com_content&view=article&id=104:fire-and-explosion-in-a-lpg-storage-facility&catid=84:safety-alerts&lang=en&Itemid=.
- [221] M. Safi, «Man dies, woman injured, as Melbourne explosion triggers crash with five cars,» The Guardian, 2015.
- [222] Bangkok Post, «Fire destroys 1,000 slum homes in India’s Mumbai,» Bangkok Post, 2015.
- [223] Trakaid, «Cylotrak: Industrial gas cylinder plant & customer delivery/ pickup tracking solution,» [En ligne]. Available: <https://www.trakaid.com/cylotrak/>.
- [224] GasStop, «About our testing process,» [En ligne]. Available: gasstopglobal.com/fr/about-our-testing-process/.
- [225] Zhuzhou Yefeng Gas Equipment, «Categories: LPG cylinder,» [En ligne]. Available: <https://www.yf-gascylinder.com/product/Promotion-empty-high-pressure-gaz-bottle-domestic-gas-cylinder.html>.
- [226] C. Abhiram, «Safety Aspects in Transportation & Storage of LPG,» 2018.
- [227] International Organization for Standardization, «Technical Report ISO/TR 16732-3: Fire safety engineering – Fire risk assessment (Part 3: Example of an industrial property),» International Organization for Standardization, 2013.
- [228] SuperGas, «Be safe from LPG leak accidents: LPG leak detector for home,» 2019. [En ligne]. Available: <https://www.supergas.com/lpg-for-Commercial/lpg-leak-detector>.
- [229] J. Alderman, «Clean vs. Clean Enough: How the Clean Cooking Industry Can Overcome its Struggles to Scale,» 16 August 2019.
- [230] J. Alderman, «Clean vs Clean Enough: How the Clean Cooking Industry Can Overcome its Struggles to Scale,» 16 August 2019. [En ligne]. Available: <https://envirofit.org/smartgas-featured-in-next-billion/>.
- [231] DA-14 Corp, «PayGo Energy,» 2019. [En ligne]. Available: <https://da-14.com/portfolio/paygo-energy>.
- [232] D. Kimemia, C. Vermaak, S. Pachauri et B. Rhodes, «Burns, scalds and poisonings from household energy use in South Africa: Are the energy poor at greater risk,» Energy for Sustainable Development, 2013.
- [233] W. A. Bizzo, B. d. Calan, R. Myers et T. Hannecart, «Safety issues for clean liquid and gaseous fuels for cooking in the scope of sustainable development,» 2004.

- [234] E. O. B. Ogedengbe et F. D. Ajibadea, «Improved Burner Efficiency and Fuel Consumption in Domestic Cooking Appliances,» Energy and Policy Research, 2017.
- [235] V. Kumar, K. E. Khan et H. S. Bitta, «Porous radiant burner for domestic cooking purpose (A Review),» International Journal of Advance Research and Innovation, 2017.
- [236] Z. H. C. Soh, S. A. C. Abdullah, M. A. Shafie et M. N. Ibrahim, «Home and Industrial Safety IoT on LPG Gas Leakage Detection and Alert System,» 2019.
- [237] SUPERGAS, «LPG leak detector for home,» 2020. [En ligne]. Available: www.supergas.com/lpg-for-Home/lpg-leak-detector.
- [238] International Gas Detectors, «TOC-10 Series domestic gas detector's,» 2020. [En ligne]. Available: <https://www.internationalgas-detectors.com/products/toc-10-series-domestic-gas-detectors/>.
- [239] Kiddle, «Nighthawk™ AC Plug-in Operated Carbon Monoxide and Explosive Gas Alarm with Digital Display,» 2020. [En ligne]. Available: <https://www.kidde.com/home-safety/en/us/products/fire-safety/co-alarms/kn-coeg-3/>.
- [240] Radon Gas Detector Reviews, «Top 10 Best Natural Gas leak Detectors for Home Safety Reviews- Amazon:2020,» 21 January 2020. [En ligne]. Available: <https://radongasdetectorreviews.com/top-10-best-natural-gas-leak-detectors-reviews-home-safety/>.
- [241] iGuardFire, «Stove fire safety,» 2020. [En ligne]. Available: <https://iguardfire.com/us/>.
- [242] M. A. Faizan et R. Thakur, «Measuring the impact of household energy consumption on respiratory diseases in India,» Global Health Research and Policy, 2019.
- [243] WLPGA (The World LPG Association), «Guidelines for the Development of Sustainable LP Gas Markets - Early-Stage Markets Edition,» 2015.
- [244] Global Innovation Fund, «Investments - PayGo Energy,» [En ligne]. Available: globalinnovation.fund/investments/paygo-energy/.
- [245] World Health Organization, «Percentage of the population using clean and polluting fuels and technologies for cooking,» 2016.b. [En ligne]. Available: <http://www.who.int/airpollution/data/en/>.
- [246] United Nations, Department of Economic and Social Affairs, «World Population Prospects: The 2019 Revision,» 2019. [En ligne]. Available: <https://population.un.org/wpp/DataQuery/>.
- [247] Ghanaweb, NPA begins nationwide LPG Door to Door campaign, Available: <https://www.ghanaweb.com/GhanaHomePage/business/NPA-begins-nationwide-LPG-Door-to-Door-campaign-646826>



A woman in Ghana cooks a meal using LPG



The Clean Cooking Alliance works with a global network of partners to build an inclusive industry that makes clean cooking accessible to the three billion people who live each day without it. Established in 2010, the Alliance is driving consumer demand, mobilizing investment to build a pipeline of scalable businesses, and fostering an enabling environment that allows the sector to thrive. Clean cooking transforms lives by improving health, protecting the climate and the environment, empowering women, and helping families save time and money.

CleanCookingAlliance.org